

POWER AMPLIFIERS

P2350/P2700

SERVICE MANUAL



● P2350

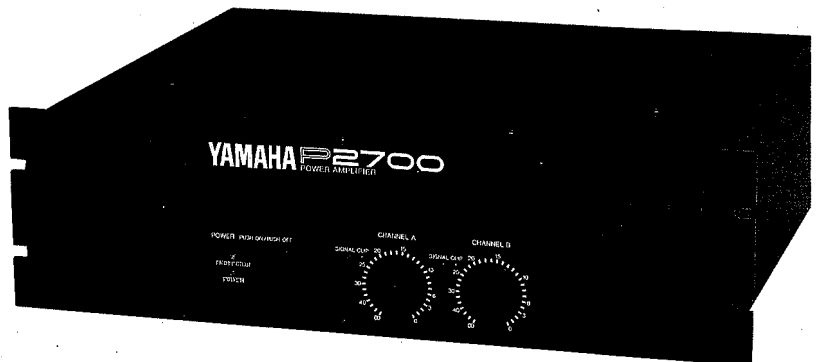

● P2700

P2350/P2700

■ CONTENTS

SPECIFICATIONS.....	1
PANEL LAYOUT.....	3
BLOCK DIAGRAM.....	4
PROTECTIVE CIRCUIT OPERATION.....	4
DIMENSIONS.....	5
CIRCUIT BOARD LAYOUT & WIRING.....	6
DISASSEMBLY PROCEDURE.....	8
IC BLOCK DIAGRAM.....	12
ADJUSTMENTS.....	12
CIRCUIT BOARDS.....	14
PARTS LIST	

IMPORTANT NOTICE

This manual has been provided for the use of authorized Yamaha Retailers and their service personnel. It has been assumed that basic service procedures inherent to the industry, and more specifically Yamaha Products, are already known and understood by the users, and have therefore not been restated.

WARNING: Failure to follow appropriate service and safety procedures when servicing this product may result in personal injury, destruction of expensive components and failure of the product to perform as specified. For these reasons, we advise all Yamaha product owners that all service required should be performed by an authorized Yamaha Retailer or the appointed service representative.

IMPORTANT: The presentation or sale of this manual to any individual or firm does not constitute authorization, certification, recognition of any applicable technical capabilities, or establish a principle-agent relationship of any form.

The data provided is believed to be accurate and applicable to the unit(s) indicated on the cover. The research, engineering, and service departments of Yamaha are continually striving to improve Yamaha products. Modifications are, therefore, inevitable and changes in specification are subject to change without notice or obligation to retrofit. Should any discrepancy appear to exist, please contact the distributor's Service Division.

WARNING: Static discharges can destroy expensive components. Discharge any static electricity your body may have accumulated by grounding yourself to the ground buss in the unit (heavy gauge black wires connect to this buss).

IMPORTANT: Turn the unit OFF during disassembly and parts replacement. Recheck all work before you apply power to the unit.

■ SPECIFICATIONS

P2700	P2350
POWER OUTPUT LEVEL STEREO: 350W + 350W; RL = 8 ohms, f = 20 Hz — 20 kHz, THD ≤ 0.1 % 500W + 500W; RL = 4 ohms, f = 20 Hz — 20 kHz, THD ≤ 0.1 % MONO: 1000W; RL = 8 ohms, f = 20 Hz — 20 kHz, THD ≤ 0.1 %	STEREO: 175W + 175W; RL = 8 ohms, f = 20 Hz — 20 kHz, THD ≤ 0.1 % 250W + 250W; RL = 4 ohms, f = 20 Hz — 20 kHz, THD ≤ 0.1 % MONO: 500W; RL = 8 ohms, f = 20 Hz — 20 kHz, THD ≤ 0.1 %
FREQUENCY RESPONSE 0 dB +0.5, -1.5 dB; f = 10 Hz — 50 kHz, RL = 8 ohms, Po = 1 W	
POWER BANDWIDTH STEREO: 10 Hz — 40 kHz; Po = 175 W, RL = 8 ohms, THD = 0.1 % 10 Hz — 40 kHz; Po = 250 W, RL = 4 ohms, THD = 0.1 % MONO: 10 Hz — 40 kHz; Po = 500 W, RL = 8 ohms, THD = 0.1 %	STEREO: 10 Hz — 40 kHz; Po = 88 W, RL = 8 ohms, THD = 0.1 % 10 Hz — 40 kHz; Po = 125 W, RL = 4 ohms, THD = 0.1 % MONO: 10 Hz — 40 kHz; Po = 250 W, RL = 8 ohms, THD = 0.1 %
TOTAL HARMONIC DISTORTION (THD) STEREO: ≤0.05%; Po = 175 W, RL = 8 ohms, f = 20 Hz — 20 kHz ≤0.07%; Po = 250 W, RL = 4 ohms, f = 20 Hz — 20 kHz MONO: ≤0.07%; Po = 500 W, RL = 8 ohms, f = 20 Hz — 20 kHz	STEREO: ≤0.05%; Po = 88 W, RL = 8 ohms, f = 20 Hz — 20 kHz ≤0.07%; Po = 125 W, RL = 4 ohms, f = 20 Hz — 20 kHz MONO: ≤0.07%; Po = 250 W, RL = 8 ohms, f = 20 Hz — 20 kHz
INTERMODULATION DISTORTION (IMD) STEREO: ≤0.03%; Po = 175 W, RL = 8 ohms, f = 60 Hz : 7 kHz, 4 : 1 ≤0.05%; Po = 250 W, RL = 4 ohms, f = 60 Hz : 7 kHz, 4 : 1 MONO: ≤0.05%; Po = 500 W, RL = 8 ohms, f = 60 Hz : 7 kHz, 4 : 1	STEREO: ≤0.03%; Po = 88 W, RL = 8 ohms, f = 60 Hz : 7 kHz, 4 : 1 ≤0.05%; Po = 125 W, RL = 4 ohms, f = 60 Hz : 7 kHz, 4 : 1 MONO: ≤0.05%; Po = 250 W, RL = 8 ohms, f = 60 Hz : 7 kHz, 4 : 1

P2350/P2700

P2700	P2350
CHANNEL SEPARATION ATT max, Input 600 ohms shunt ≥ 70 dB; Po = 175 W, RL = 8 ohms, f = 20 Hz — 20 kHz ≥ 80 dB; Po = 175 W, RL = 8 ohms, f = 1 kHz	
RESIDUAL NOISE ≤ -75 dBm; ATT min, fc = 12.7 kHz -6 dB/oct LPF ≤ -80 dBm; ATT min, IHF-A network	
SIGNAL-TO-NOISE RATIO ≥ 100 dB; Input 600 ohms shunt, fc = 12.7 kHz -6 dB/oct LPF ≥ 110 dB; Input 600 ohms shunt, IHF-A network	
DAMPING FACTOR > 100; RL = 8 ohms, f = 1 kHz	
SLEW RATE ± 40 V/μ sec; Stereo, RL = 8 ohms, Full Swing ± 50 V/μ sec; Mono, RL = 8 ohms, Full Swing	± 30 V/μ sec; Stereo, RL = 8 ohms, Full Swing ± 40 V/μ sec; Mono, RL = 8 ohms, Full Swing
SENSITIVITY + 4 dBm; Po = 350 W, 8 ohms, ATT max, f = 1 kHz	+ 4 dBm; Po = 175 W, 8 ohms, ATT max, f = 1 kHz
VOLTAGE GAIN 32.5 dB; ATT max, f = 1 kHz, RL = 8 ohms	30.0 dB; ATT max, f = 1 kHz, RL = 8 ohms
INPUT IMPEDANCE ≥ 15 kohms; Balance or Unbalance, ATT max	
INDICATORS POWER Red LED; turns on when Power is On PROTECTION Red LED; turns on when protection or muting is On CLIPPING Red LED; turns on when THD ≥ 1 % SIGNAL Green LED; turns on when Signal output above 4 ohms, 1 W (20 Hz — 20 kHz)	
PROTECTION CIRCUITS OUTPUT MUTING 5 sec. ± 3 sec.; after power is on DC sense DC ± 2 V; output shunt off THERMAL ≥ 100 degree C.; heat sink temp. PC LIMITER RL ≤ 2 ohms	
FAN CIRCUIT FAN HI-SPEED; 70 deg. C. (heat sink temp.) FAN LO-SPEED; 60 deg. C.	
CONTROLS FRONT POWER SWITCH; push on/ push off INPUT ATTENUATOR; 31-position, log-linear, detented and dB-calibrated REAR MODE SWITCH; Stereo/Mono (BTL) (Except for P2700 Canadian model)	
POWER REQUIREMENTS U.S. & Canadian Models; 120 V, 60 Hz General Model; 220/240 V, 50/60 Hz	
POWER CONSUMPTION U.S. Model; 1000 W Canadian Model; 1000 W/1200 VA General Model; 1000 W	U.S. Model; 700 W Canadian Model; 700 W/900 VA General Model; 700 W
DIMENSIONS (W x H x D) 480 x 143.5 x 435.2 mm (18-7/8" x 5-5/8" x 17-1/8")	
WEIGHT 24 kg (52 lbs. 14 oz)	19 kg (41 lbs. 14 oz)

* 0 dB = 0.775 Vr.m.s.

* Specifications and appearance subject to change without notice.

PANEL LAYOUT

● Front Panel

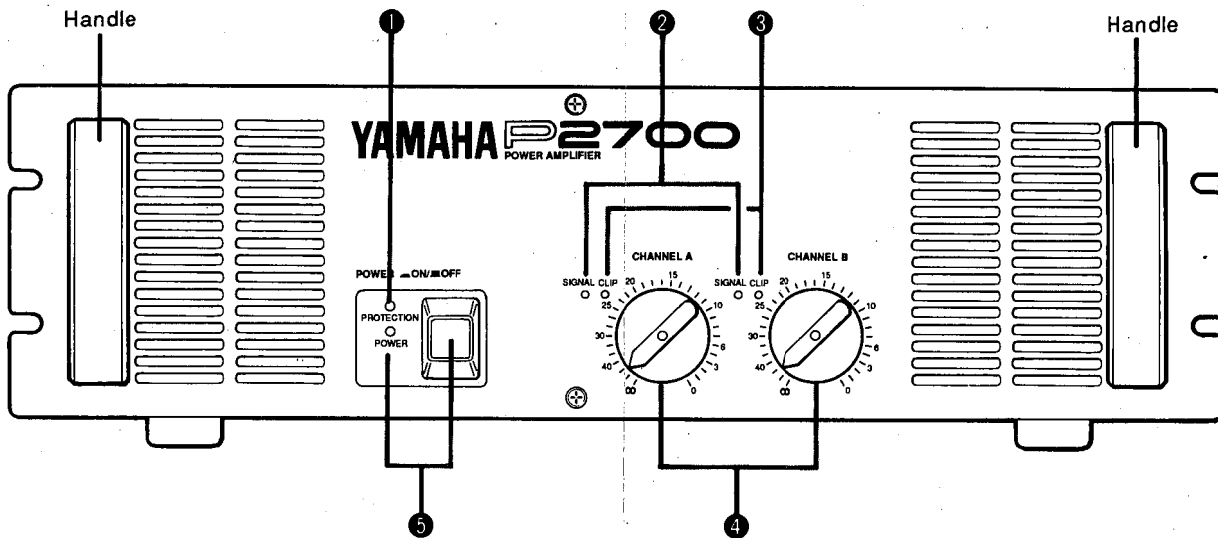

- ❶ PROTECTION Indicator
- ❷ SIGNAL Indicators
- ❸ CLIP Indicators
- ❹ Input Attenuators
- ❺ POWER Switch & Indicator

● Rear Panel

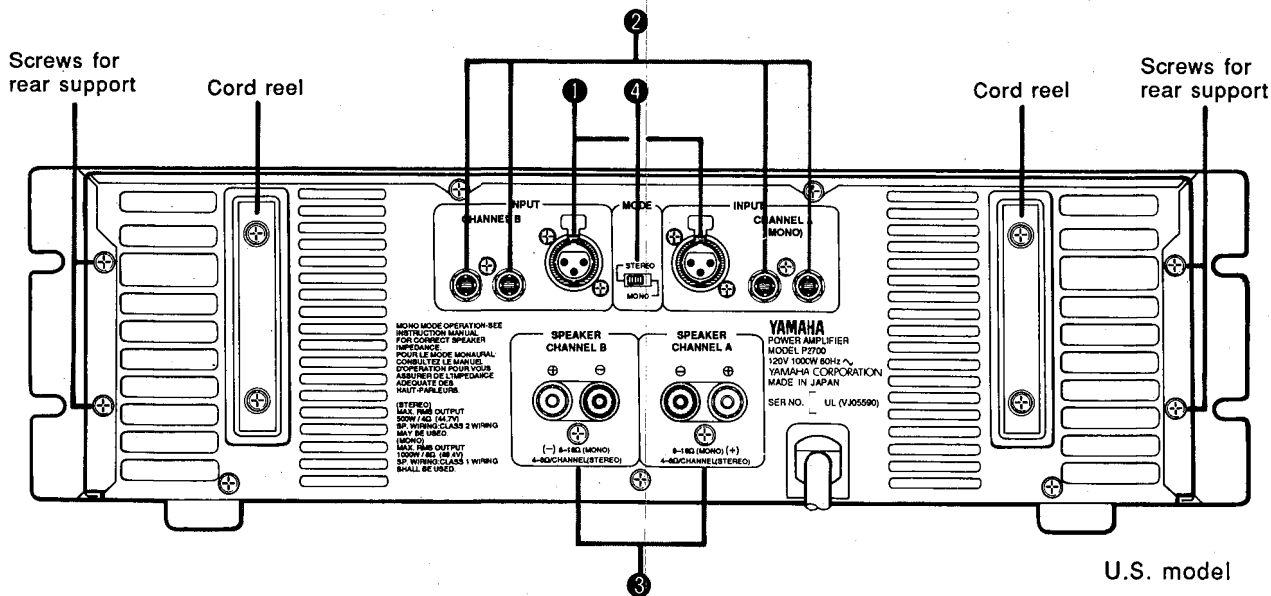

- ❶ INPUT Connectors (XLR-3-31 type)
- ❷ INPUT Connectors (TRS Phone type)
- ❸ SPEAKER Terminals
- ❹ MODE Switch (Except for P2700 canadian model)

P2350/P2700

■ BLOCK DIAGRAM

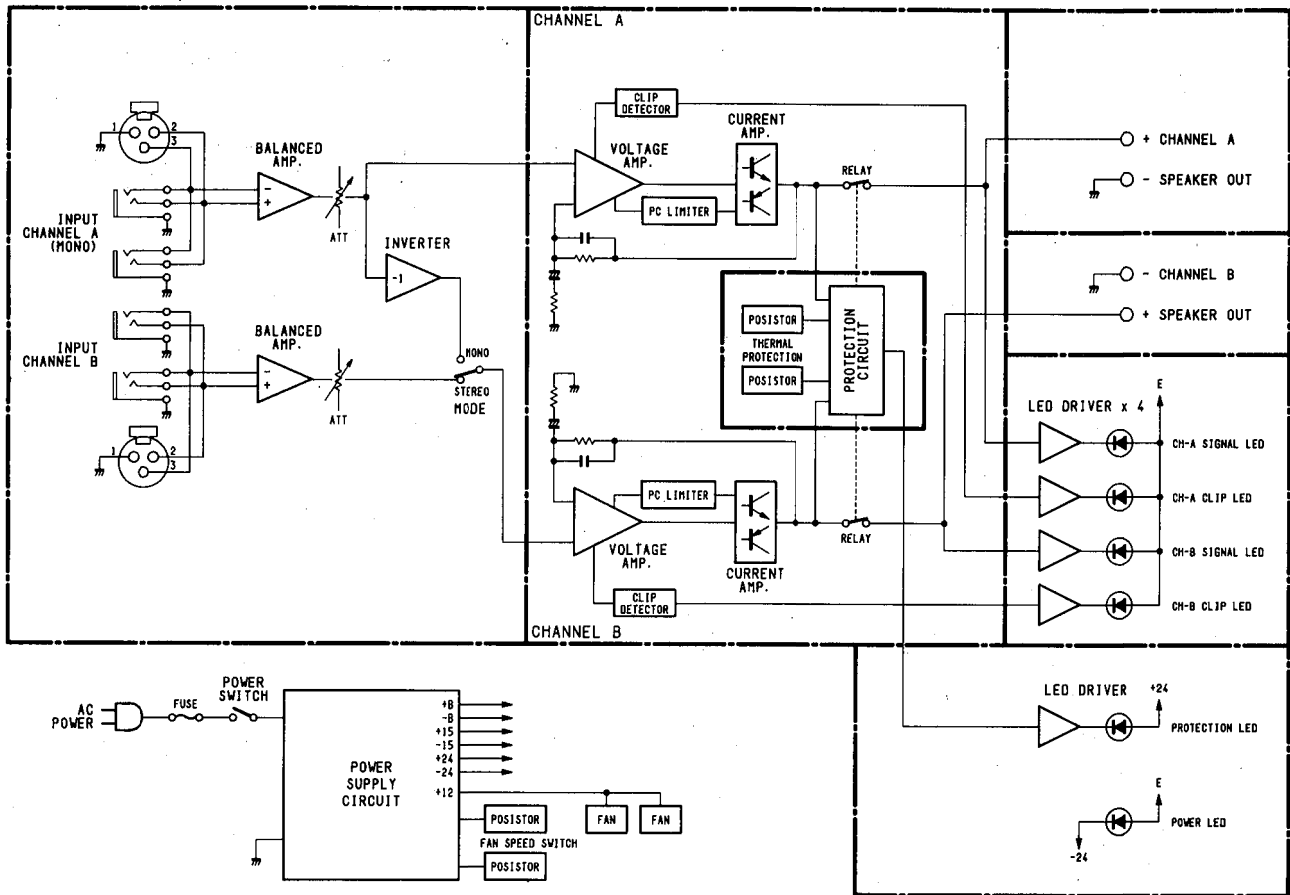

■ PROTECTIVE CIRCUIT OPERATION

Indicator display	Probable cause	Remedy	Protective circuit operation
CLIP indicator lights.	There is a short at a speaker terminal, amplifier terminal, or wire.	Locate and correct the cause of the short.	The PC limiter circuit operates to protect the power transistors.
	The amplifier load is excessive.	Use a speaker system with an impedance of at least 4 ohms (stereo) or 8 ohms (monaural).	Same as above.
PROTECTION indicator lights.	The heat sink temperature has exceeded 100°C.	Check the amplifier ventilation conditions and take appropriate measures to improve airflow around the amplifier.	The thermal protection circuit operates to protect the power transistors.
	A DC voltage of +/-2V or greater was generated in the power amplifier's output circuit.		The relay operates to protect the speaker system.

DIMENSIONS

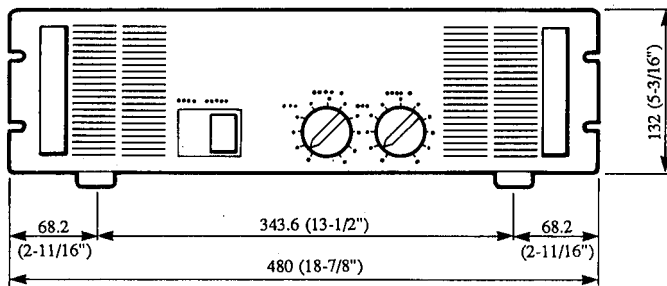
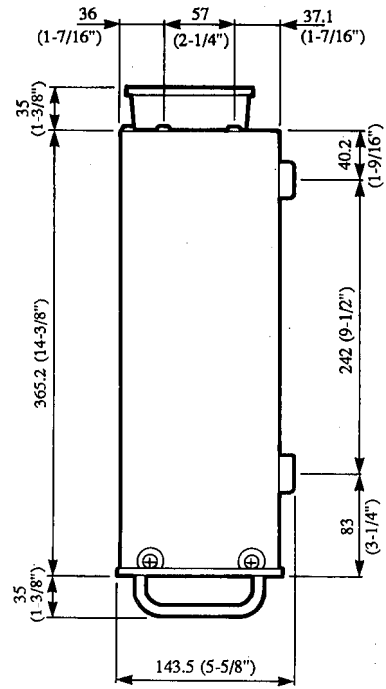
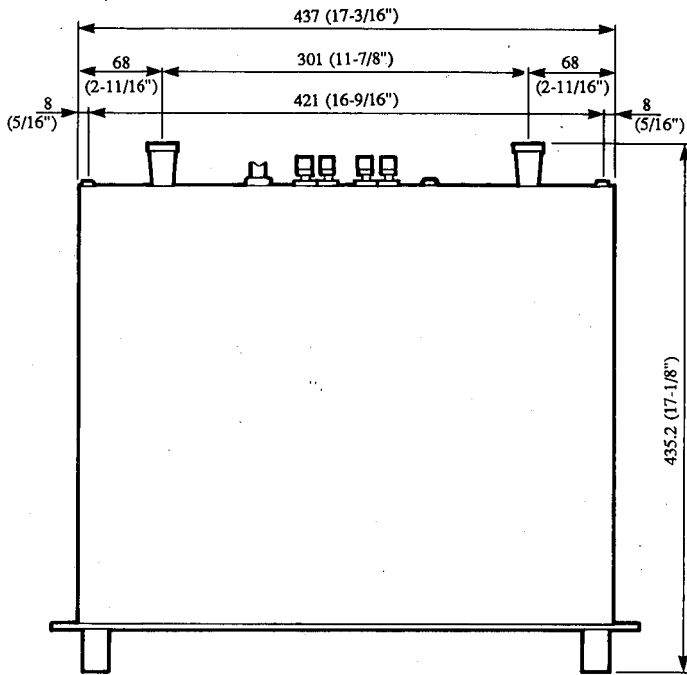

Unit: mm (inch)

CIRCUIT BOARD LAYOUT & WIRING

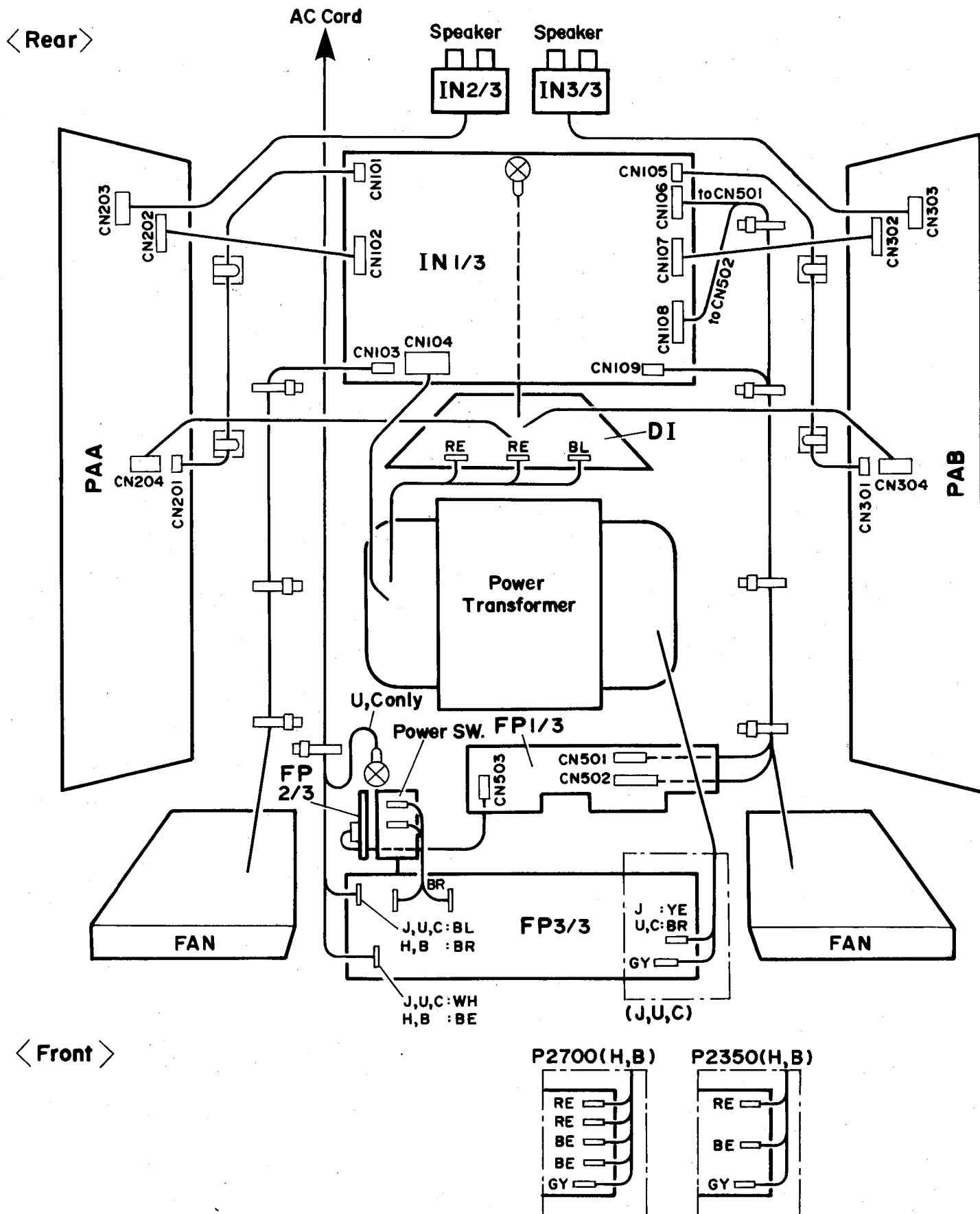

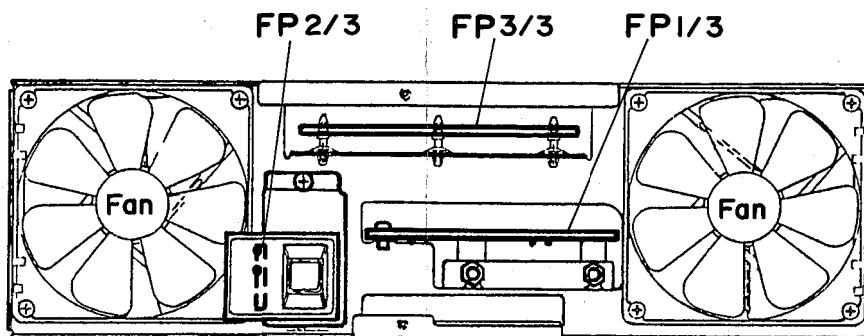
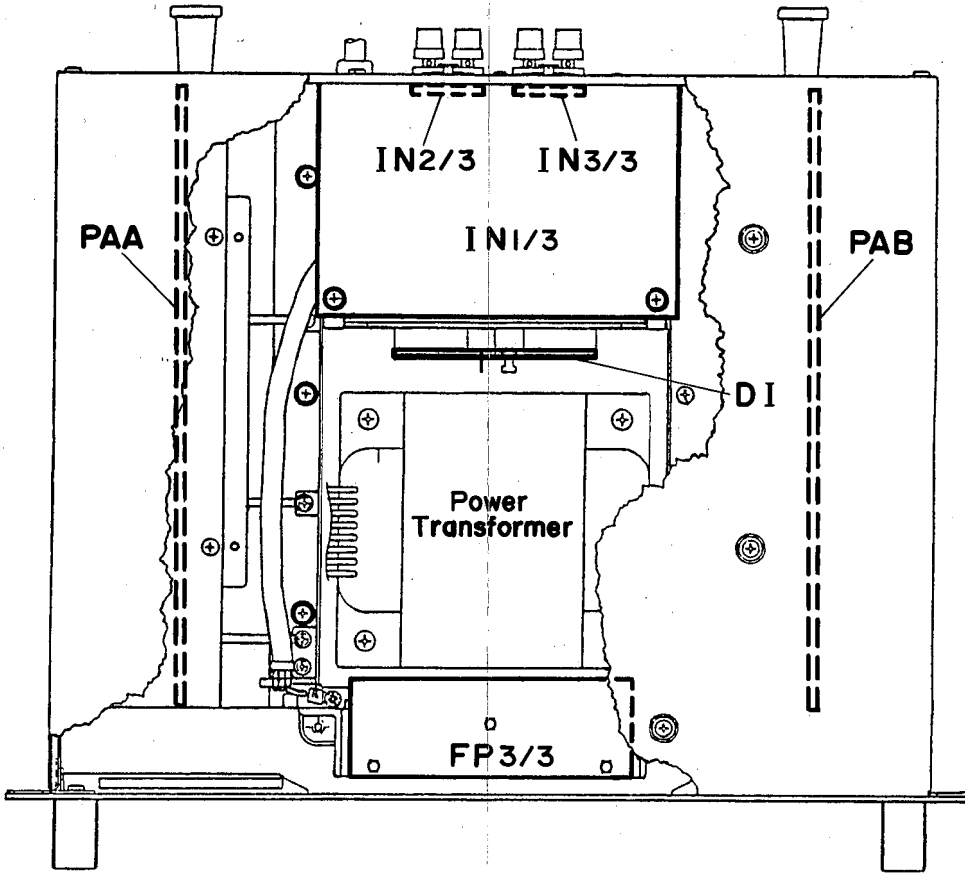

P2350/P2700

DISASSEMBLY PROCEDURE

1. Top Cover Removal

1-1. Remove the sixteen (16) screws marked in the figure as **A** (4 × 8 Bind head tapping screw), then the Top cover can be removed. (Fig. 1)

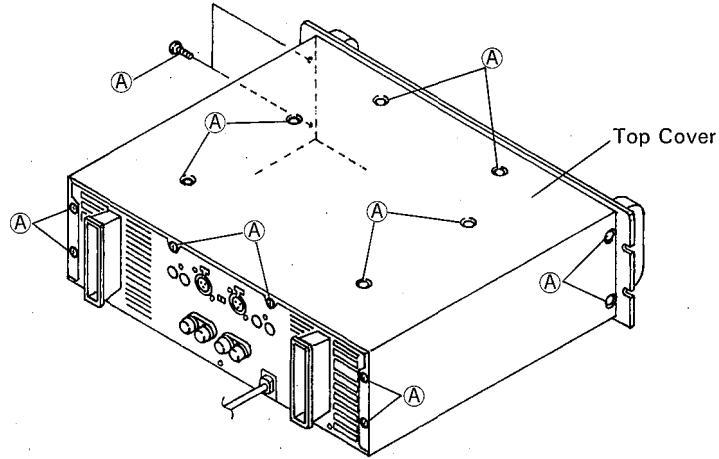

(Fig. 1)

2. FP 3/3 Circuit Board Removal

2-1. Remove the Top cover. (see procedure 1 – Top Cover Removal)

2-2. Lift the FP 3/3 circuit board up, while pushing the fin of three (3) PCB supporters marked **B**, the FP 3/3 circuit board can be removed. (Fig. 2)

< Top View >

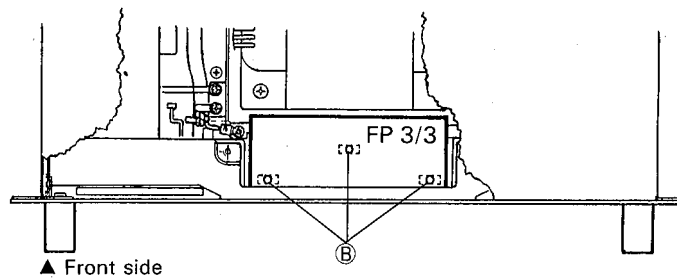

(Fig.2)

3. Front Panel Assembly Removal

3-1. Remove the Top cover. (see procedure 1.)

3-2. Remove the FP 3/3 circuit board. (see procedure 2.)

3-3. Remove the two (2) screws marked **C** (4 × 8 Bind head screw) and four (4) screws marked **D** (4 × 12 Bind head tapping screw). (Fig. 3 and Fig. 4)

3-4. The Front panel assembly can be removed by disconnecting the wire haneses.

< Top View >

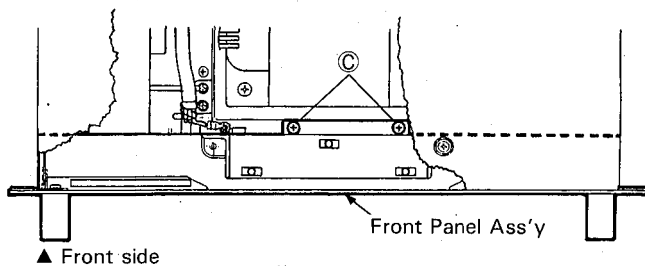

(Fig. 3)

< Right Side View >

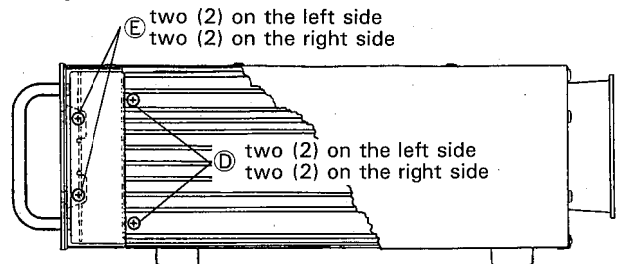

(Fig. 4)

4. FP 1/3, FP 2/3 Circuit Boards and Power Switch Removal

- 4-1. Remove the Top cover. (see procedure 1.)
- 4-2. Remove the FP 3/3 circuit board. (see procedure 2.)
- 4-3. Remove the Front panel assembly. (see procedure 3.)
- 4-4. Remove the four (4) screws marked ⑤ (4 × 8 Bind head screw) and two (2) screws marked ⑥ (3 × 8 Flat head screw) to remove the Front panel. (Fig. 4 and Fig. 5)
- 4-5. Removal of FP 1/3 circuit board
 - 4-5-1. Pull out the two (2) Attenuator knobs.
 - 4-5-2. After the two (2) hex. nuts marked ③ (φ8) and plastic rivet marked ④ have been removed, the FP 1/3 circuit board can be removed. (Fig. 6)
- 4-6. Removal of FP 2/3 circuit board
 - 4-6-1. Remove the screw marked ① (4 × 8 Bind head tapping screw) to remove the switch angle with the Power switch and FP 2/3 circuit board.
 - 4-6-2. Remove the two (2) plastic rivets marked ②, the FP 2/3 circuit board can be removed from the Switch angle. (Fig. 7)
- 4-7. Removal of Power switch
 - 4-7-1. Remove the switch angle. (see procedure 4-6-1.)
 - 4-7-2. Remove the switch escutcheon, while pushing the hooks of the switch escutcheon inward. (Fig. 7)
 - 4-7-3. Pull out the push button and remove the two (2) screws marked ⑦ (3 × 8 Bind head screw), then remove the Power switch from the switch angle. (Fig. 8)

< Front View >

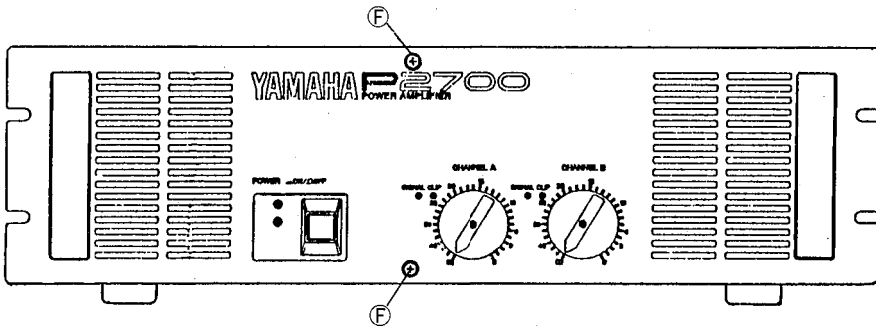

(Fig. 5)

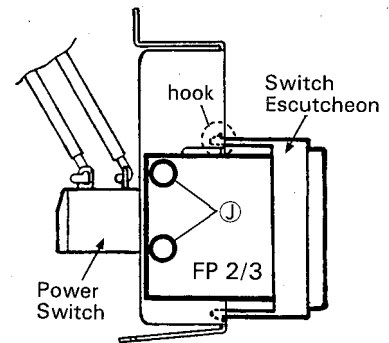

(Fig. 7)

< Front View >

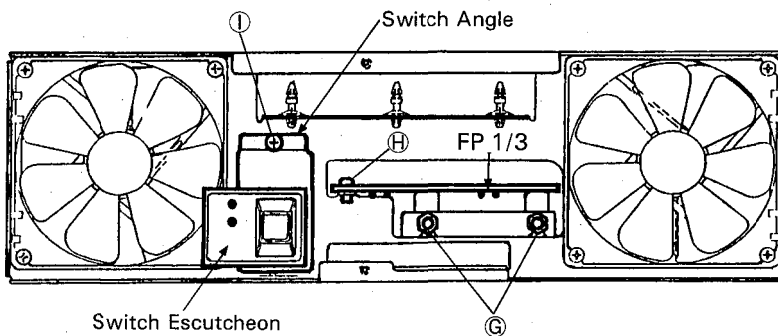

(Fig. 6)

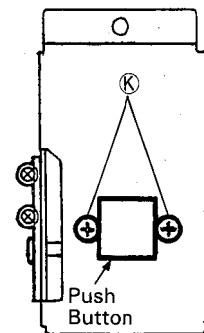

(Fig. 8)

5. PAA and PAB Units Removal

- 5-1. Remove the Top cover. (see procedure 1.)
- 5-2. Remove the FP 3/3 circuit board. (see procedure 2.)
- 5-3. Remove the Front panel assembly. (see procedure 3.)
- 5-4. Remove the three (3) screws marked **L** (4 x 8 Bind head screw) and the screw marked **M** (4 x 12 Bind head tapping screw). (Fig. 9 and Fig. 10)
- 5-5. The PAA unit can be removed by disconnecting the wire harnesses.
- 5-6. The PAB unit can be removed by the same way as in the PAA unit removal.

6. PAA and PAB Circuit Boards Removal

- 6-1. Remove the Top cover. (see procedure 1.)
- 6-2. Remove the FP 3/3 circuit board. (see procedure 2.)
- 6-3. Remove the Front panel assembly. (see procedure 3.)
- 6-4. To remove the PAA circuit board, remove the PAA unit.
In the case of the PAB circuit board removal, remove the PAB unit.
- 6-5. After the screws marked **N** (3 x 12 Pan head screw P2350: 8 pcs, P2700: 10 pcs) have been removed, the transistor holders and the PAA circuit board can be removed. (Fig. 11)
- 6-6. The PAB circuit board can be removed by the same way as in the PAA circuit board removal.

< Top View >

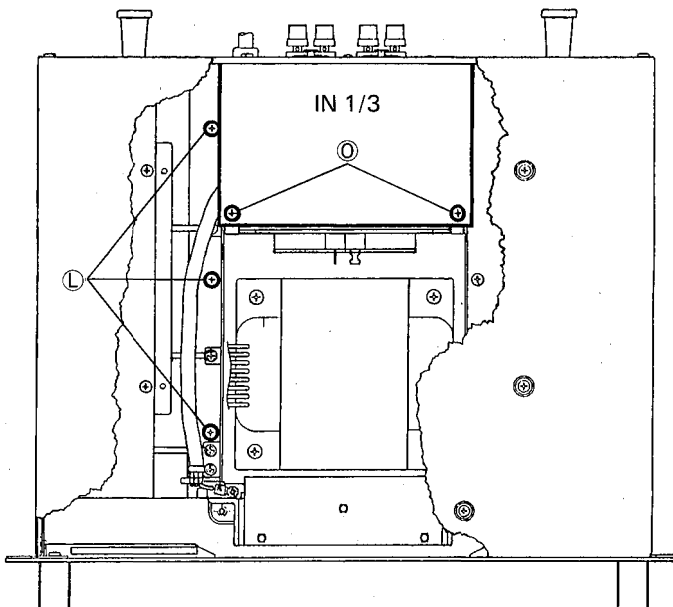

(Fig. 9)

< Rear View >

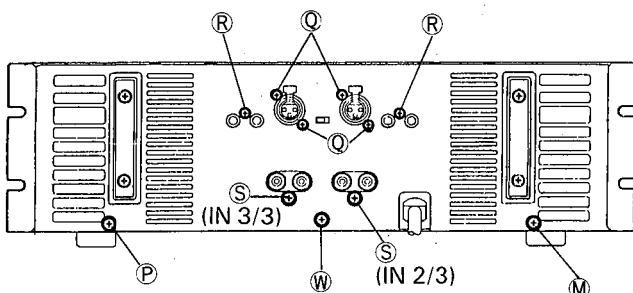

(Fig. 10)

< PAA Unit >

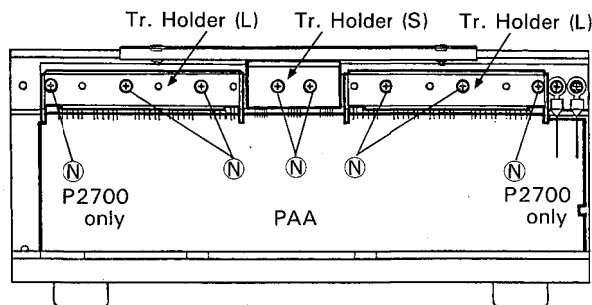

(Fig. 11)

7. Rear Panel Assembly Removal

- 7-1. Remove the Top cover. (see procedure 1.)
- 7-2. Remove the two (2) screws marked ㉟ (3 × 8 Bind head tapping screw), screw marked ㊸ (4 × 12 Bind head tapping screw), screw marked ㊹ (4 × 12 Bind head tapping screw) and screw marked ㊺ (4 × 8 Bind head tapping screw). (Fig. 9 and Fig. 10)
- 7-3. The Rear panel assembly can be removed by disconnecting the wire harnesses.

8. IN 1/3, IN 2/3 and IN 3/3 Circuit Boards Removal

- 8-1. Remove the Top cover assembly. (see procedure 1.)
- 8-2. Remove the Rear panel assembly. (see procedure 7.)
- 8-3. Removal of IN 1/3 circuit board
 - 8-3-1. Remove the four (4) screws marked ㉟ (3 × 8 Bind head screw) and the two (2) screws marked ㊻ (3 × 8 Bind head tapping screw), then remove the IN 1/3 circuit board. (Fig. 10)
- 8-4. Removal of IN 2/3 and IN 3/3 circuit boards
 - 8-4-1. The IN 2/3 and IN 3/3 circuit boards can be removed by removing the screw marked ㊼ (4 × 10 Bind head tapping screw). (Fig. 10)

9. DI Circuit Board Removal

- 9-1. Remove the Top cover assembly. (see procedure 1.)
- 9-2. Remove the Rear panel assembly. (see procedure 7.)
- 9-3. Remove the three (3) screws marked ㉟ (4 × 8 Bind head screw) to remove the holder retaining the electrolytic cap. with DI circuit board. (Fig. 12)
- 9-4. The DI circuit board can be removed from the holder by removing the screw ㊽ (4 × 16 Bind head screw). (Fig. 13)

10. Power Transformer Removal

- 10-1. Remove the Top cover. (see procedure 1.)
- 10-2. Remove the four (4) screws marked ㊾ (5 × 10 Bind head screw) and disconnect the wire harnesses, the Power transformer can be removed. (Fig. 12)

< Top View >

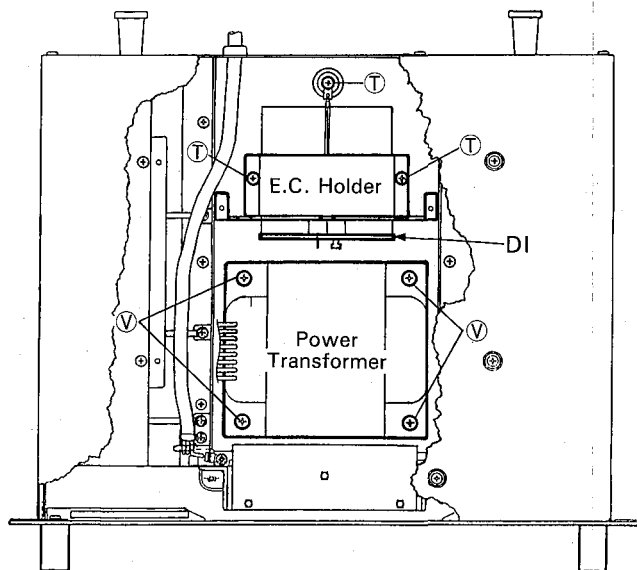

(Fig. 12)

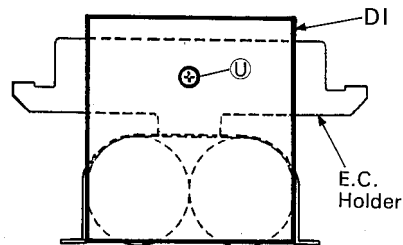

(Fig. 13)

P2350/P2700

IC BLOCK DIAGRAM

- **M5238P** (XA013001)
Dual Operational Amplifier

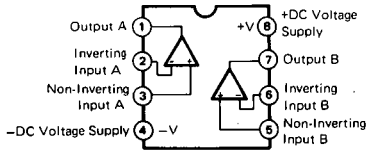

- **TA7317P** (IG034800)
Relay Driver

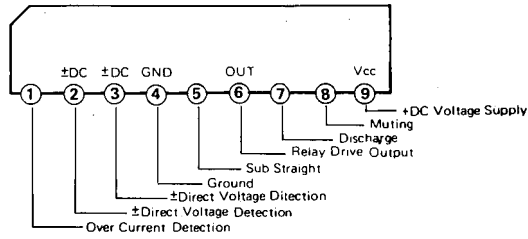

ADJUSTMENTS

Before performing any following adjustments, set the unit as follows:

1. Set the ATTENUATIONS at "0".
2. Input terminal: XLR pin 2 is HOT, pins 1 and 3 GROUND.
3. MODE switch: STEREO.
4. Connect 4 ohm across each of the OUTPUT terminals under test.

- **ADJUSTMENT SPECIFICATIONS**

Before testing for specifications, confirm AC line voltage is the rated value $\pm 10\%$.

First GROUND the INPUT terminal.

Adjustment item	Adjust	Test Point	Rating	Conditions
IDLE CURRENT	VR201	TP + -	9 mV \pm 1 mV	
	VR301	TP + -	9 mV \pm 1 mV	
	VR201	TP + -	15 mV \pm 2 mV	Unit ON 15 minutes
	VR301	TP + -	15 mV \pm 2 mV	Unit ON 15 minutes
DC OFFSET	OUTPUT terminal A		0 V \pm 0.5 V	
	OUTPUT terminal B		0 V \pm 0.5 V	

* VR201 and VR202, TP+ and TP- are located on the PAA and PAB circuit boards.

1. MUTING TEST

After applying power to the unit, the PROTECTION indicator should remain ON for 6 ± 2 seconds and then the indicator should go out.

2. GAIN TEST

When a sinewave of 1 kHz at -10 dB is applied to the INPUT, the OUTPUT should be $+22.3 \pm 1.5$ dB for P2700 or $+20.0 \pm 1.5$ dB for P2350.

3. FREQUENCY RESPONSE TEST

When a sinewave of 20 Hz, 1 kHz and 20 kHz at -10 dB is applied to the INPUT, the OUTPUT should be as follows: (taking the 1 kHz as reference).

20 Hz: $0 \text{ dB} \pm 0.5 \text{ dB}$
 20 kHz: $-0.5 \text{ dB} \pm 0.5 \text{ dB}$

4. HARMONIC DISTORTION TEST

When a high quality sinewave is applied at 20 Hz, 1 kHz and 20 kHz, the HARMONIC DISTORTION should be as follows:

Power output level (4 ohm)	T.H.D		
	20 Hz	1 kHz	20 kHz
500W + 500W (P2700)	$\leq 0.1\%$	$\leq 0.01\%$	$\leq 0.1\%$
250W + 250W (P2350)	$\leq 0.1\%$	$\leq 0.01\%$	$\leq 0.1\%$

5. CHANNEL SEPARATION TEST ($R_L = 8$ ohm)

- 5-1 Input a sinewave of -5 dB, 20 kHz into channel A.
- 5-2 Short the INPUT for channel B with a 600 ohm load.
- 5-3 Set the OUTPUT of channel A at a reference of 0 dB.
- 5-4 If channel B ATTENUATOR is set to the same as channel A, channel B should be less than -70 dB.

6. RESIDUAL NOISE

- 6-1 Set the INPUT ATTENUATOR to "0".
- 6-2 Short the INPUT with a 600 ohm load, OUTPUT load 4 ohm.
- 6-3 Measure the OUTPUT, RESIDUAL NOISE level should be -68 dB or lower.
- 6-4 Set the INPUT ATTENUATOR to MINIMUM, the RESIDUAL should be less than -75 dB.

7. SIGNAL INDICATOR TEST

When a sinewave of 1 kHz is input signal level is adjusted to equal to or greater than 2.0 volt output, the SIGNAL INDICATOR should be ON.

8. CLIPPING INDICATOR TEST

When a sinewave of 1 kHz signal is adjusted to produce equal or greater than 1.0% harmonic distortion on the OUTPUT, the CLIP INDICATOR should be ON.

■ CIRCUIT BOARDS

● PAA Circuit Board

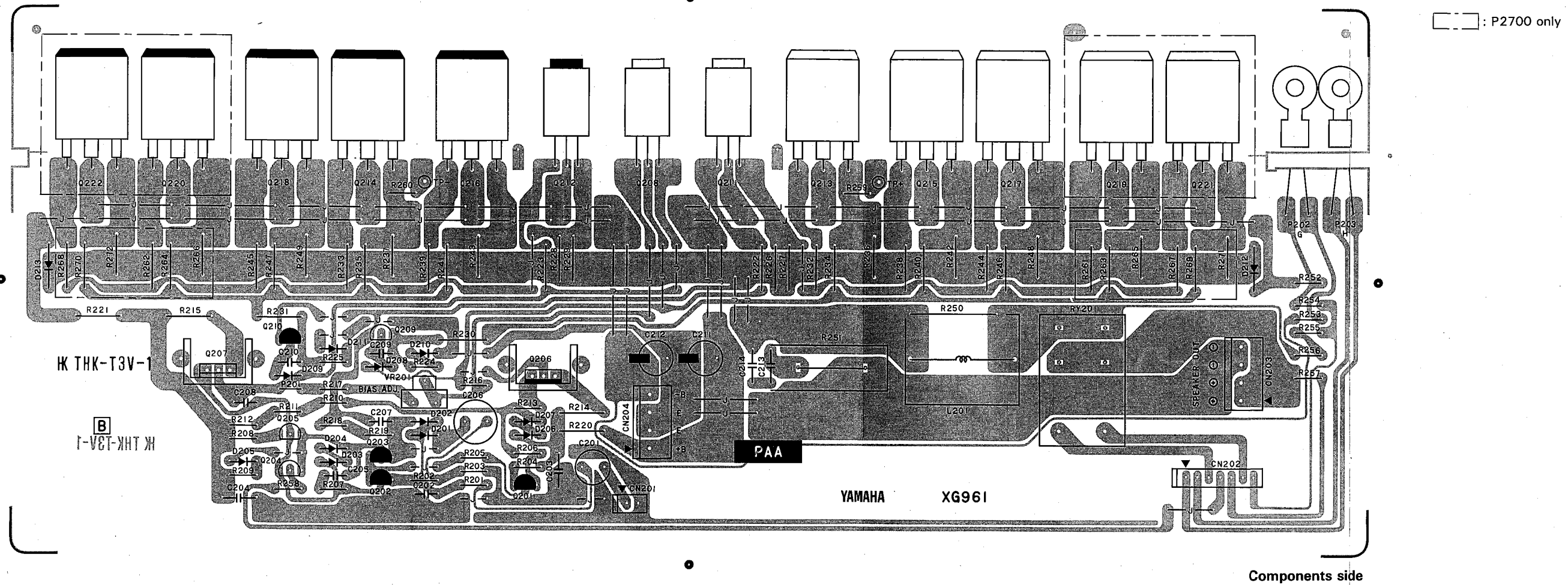

Notes)

Circuit Board:	PAA (VI997600) XG961B0 (P2350) PAA (VI997500) XG961B0 (P2700)		
1. Transistor	Q201~203, 210: 2SA970 GR, BL (IA097000) Q204, 205, 209: 2SC2240 GR, BL (IC224000) Q206: 2SA1546 (IX805240) Q207: 2SC4001 (IX805250) Q208: 2SC3298 (IC329810) Q211 (P2350): 2SC3298 (IC329810) (P2700): 2SC3298B (IC329850) Q212 (P2350): 2SA1306 (IA130610) (P2700): 2SA1306B (IA130650) Q213, 215, 217: 2SC3856 (IX609760) Q214, 216, 218: 2SA1492 (IX609750) Q219, 221: 2SC3856 (IX609760) Q220, 222: 2SA1492 (IX609750)	3. Flame Proof Carbon Resistor R214, 215: 8Ω 1/4W J (HV354820) R220, 221: 10Ω 1/4W J (HV354100) R222, 223, 226~229: 220Ω 1/4W J (HV355220) R230, 231: 3.3KΩ 1/4W J (HV356330) R232, 233, 238, 239, 244, 245: 4.7Ω 1/4W J (HV353470) R234, 235, 240, 241, 246, 247: 100Ω 1/4W J (HV355100) R261, 262, 267, 268: 4.7Ω 1/4W J (HV353470) (P2700 only) R263, 264, 269, 270: 100Ω 1/4W J (HV355100) (P2700 only)	7. Trimmer Potentiometer VR201: B470 3P H1052A (HT410370) BIAS ADJ.
2. Diode	D201~209: 1SS133 (IF003450) D210, 211: 1SS146 (VI783000) D212, 213: 1S1888 (IH000320)	4. Wire Wound Resistor R236, 237, 242, 243, 248, 249: 0.47Ω 5W K (HZ003600) R251: 10Ω 5W (HM654100) R265, 266, 271, 272: 0.47Ω 5W K (HZ003600) (P2700 only)	8. Maica Cap. C207: 15P 500V J (FU351150) C208: 5P 500V J (FU350500)
		5. Metal Oxide Film Resistor R250: 4.7Ω 2W J (VC769900)	9. Mylar Cap. C203, 204, 213, 214: 0.1μ 100V K (FZ005200)
		6. Positive Thermistor P201: PTH59F04BE471TS (VE404900) P202: PTH487A01BG471 (VI518000) P203: PTH487A01BH471 (VJ087200)	10. Electrolytic Cap. C211, 212 (P2350): 4.7μ 100V (UH296470) (P2700): 4.7μ 160V (UJ706470)
			11. Coil L201: 2mH GD90058 GY (GD900580)
			12. Relay RY201: DC24V JC2AD (KC001410)

P2350 : 3NA-VI99760 
P2700 : 3NA-VI99750 

● PAB Circuit Board

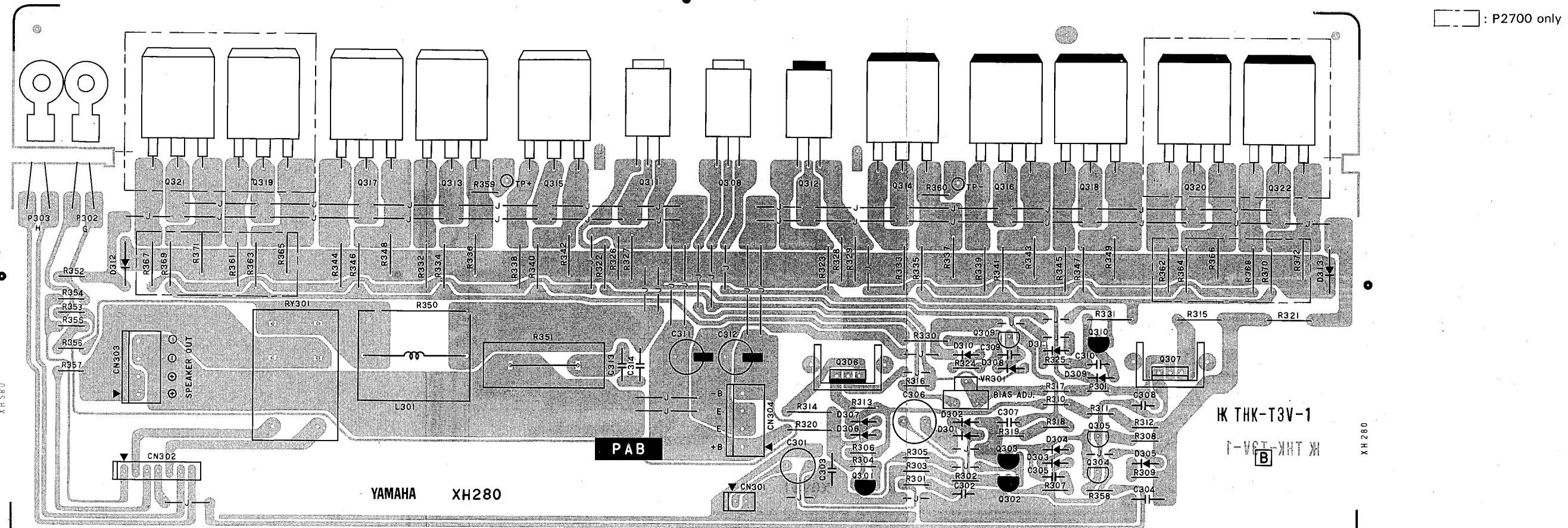

Components side

Notes)

Circuit Board:	PAB (VI997900) XH280B0 (P2350) PAB (VI997800) XH280B0 (P2700)
1. Transistor	
Q301 ~ 303, 310:	2SA970 GR, BL (IA097000)
Q304, 305, 309:	2SC2240 GR, BL (IC224000)
Q306:	2AA1546 (IX805240)
Q307:	2SC4001 (IX805250)
Q308:	2SC3298 (IC329810)
Q311 (P2350):	2SC3298 (IC329810)
(P2700):	2SC3298B (IC329850)
Q312 (P2350):	2SA1306 (IA130610)
(P2700):	2SA1306B (IA130650)
Q313, 315, 317:	2SC3856 (IX609760)
Q314, 316, 318:	2SA1492 (IX609750)
Q319, 321:	2SC3856 (IX609760) (P2700 only)
Q320, 322:	2SA1492 (IX609750) (P2700 only)
2. Diode	
D301 ~ 309:	1SS133 (IF003450)
D310, 311:	1SS146 (VI783000)
D312, 313:	1S1888 (IH000320)

3. Flame Proof Carbon Resistor	
R314, 315:	82Ω 1/4W J (HV354820)
R320, 321:	10Ω 1/4W J (HV354100)
R322, 323,	
326 ~ 329:	220Ω 1/4W J (HV355220)
R330, 331:	3.3KΩ 1/4W J (HV356330)
R332, 333, 338,	
339, 344, 345:	4.7Ω 1/4W J (HV353470)
R334, 335, 340,	
341, 346, 347:	100Ω 1/4W J (HV355100)
R361, 362, 367, 368:	4.7Ω 1/4W J (HV353470) (P2700 only)
R363, 364, 369, 370:	100Ω 1/4W J (HV355100) (P2700 only)
4. Wire Wound Resistor	
R336, 337, 342,	
343, 348, 349:	0.47Ω 5W K (HZ003600)
R351:	10Ω 5W (HM654100)
R365, 366, 371, 372:	0.47Ω 5W K (HZ003600) (P2700 only)
5. Metal Oxide Film Resistor	
R350:	4.7Ω 2W J (VC769900)
6. Positive Thermistor	
P301:	PTH59F04BE471TS (VE404900)
P302:	PTH487A01BG471 (VI518000)
P303:	PTH487A01BH471 (VJ087200)

7. Trimmer Potentiometer	
VR301:	B470 3P H1052A (HT410370) BIAS ADJ.
8. Maica Cap.	
C307:	15P 500V J (FU351150)
C308:	5P 500V J (FU350500)
9. Mylar Cap.	
C303, 304, 313, 314:	0.1μ 100V K (FZ005200)
10. Electrolytic Cap.	
C311, 312 (P2350):	4.7μ 100V (UH296470)
(P2700):	4.7μ 160V (UJ706470)
11. Coil	
L301:	2mH GD90058 GY (GD900580)
12. Relay	
RY301:	DC24V JC2AD (KC001410)

● IN Circuit Boards

IN 1/3

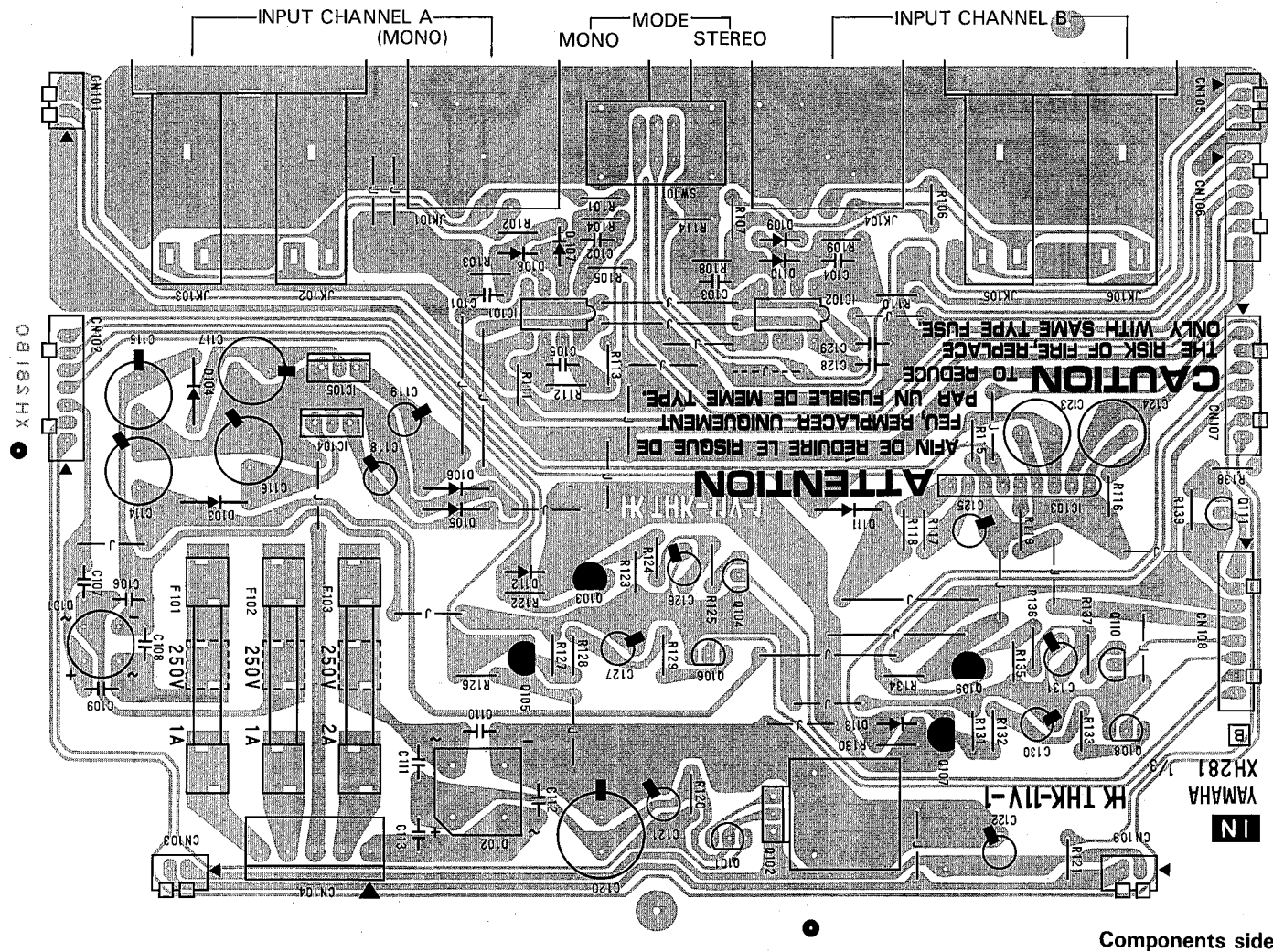

Components side

Notes)

IN 2/3

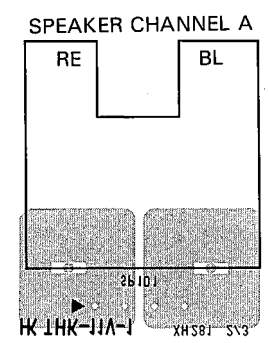

Pattern side

IN 3/3

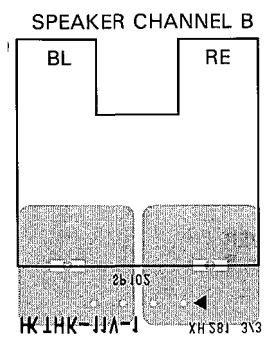

Pattern side

- Circuit Board: IN (VJ143200) XH281B0 (P2350 J)
IN (VJ143300) XH281B0 (P2350 U, C)
IN (VJ143500) XH281B0 (P2350 H, B)
IN (VI996000) XH281B0 (P2700 J)
IN (VI996100) XH281B0 (P2700 U)
IN (VI997000) XH281B0 (P2700 C)
IN (VI996200) XH281B0 (P2700 H, B)
- Circuit Board: IN (VJ143200) XH281B0 (P2350 J)
IN (VJ143300) XH281B0 (P2350 U, C)
IN (VJ143500) XH281B0 (P2350 H, B)
IN (VI996000) XH281B0 (P2700 J)
IN (VI996100) XH281B0 (P2700 U)
IN (VI997000) XH281B0 (P2700 C)
IN (VI996200) XH281B0 (P2700 H, B)
- IC
IC101, 102: M5238P (XA013001) OP AMP.
IC103: TA7317P (IG034800) SP PROTECTION
IC104: NJM7815FA (XD853A00) REGULATOR
IC105: NJM7915FA (XD854A00) REGULATOR
 - Transistor
Q101, 104, 106, 108, 110, 111: 2SC2240 GR, BL (IC224000)
Q102: 2SC3298 (IC329840)
Q103, 105, 107, 109: 2SA970 GR, BL (IA097000)
 - Diode
D103~106, 111: 10E-1 (IH001540)
D107~110, 112, 113: 1SS133 (IF003450)

- Diode Stack
D101: 1G4B1 1.5A 400V (IH001400)
D102: S2VB20 2A 200V (IH001120)
- Metal Film Resistor
R101, 102, 106, 107: 15KΩ 1/5W F (VA074600)
R103, 104, 108, 109: 12KΩ 1/5W F (VB067600)
R111, 112, 114: 51KΩ 1/5W F (VB068900)
- Ceramic Cap.
C106~113: 0.0047μ 500V M (FH223470)
- Electrolytic Cap.
C116, 117: 470μ 35V (UJ658470)
C120: 1000μ 25V (UJ849100)
- Slide Switch
SW101: SSP32204 (KA401280) MODE (J, U, H, B)
- Phone Jack
JK102, 103, 105, 106: HLJ1520 (LB202300) INPUT CH.A/B
- XLB Connector
JK101, 104: XLB-3-31PCV (LB302320) INPUT CHANNEL A, B

- Fuse
F101, 102 (J): T 1A 250V (KB000330)
(U, C): T 1A 250V (KB001060)
(H, B): T 1A 250V S (KB001770)
F103 (J): T 2A 250V (KB000350)
(U, C): T 2A 250V (KB001240)
(H, B): T 2A 250V S (KB001330)
- Speaker Terminal
SP101 (P2350): 2P # 554 (LA005540) CHANNEL A
(P2700): MSP202-1 (VI356300) CHANNEL A
SP102 (P2350): 2P # 553 (LA005530) CHANNEL B
(P2700): MSP202 (VI314700) CHANNEL B
- Marked : Jumper wire: P2700 Canadian model only

● DI Circuit Board (P2350)

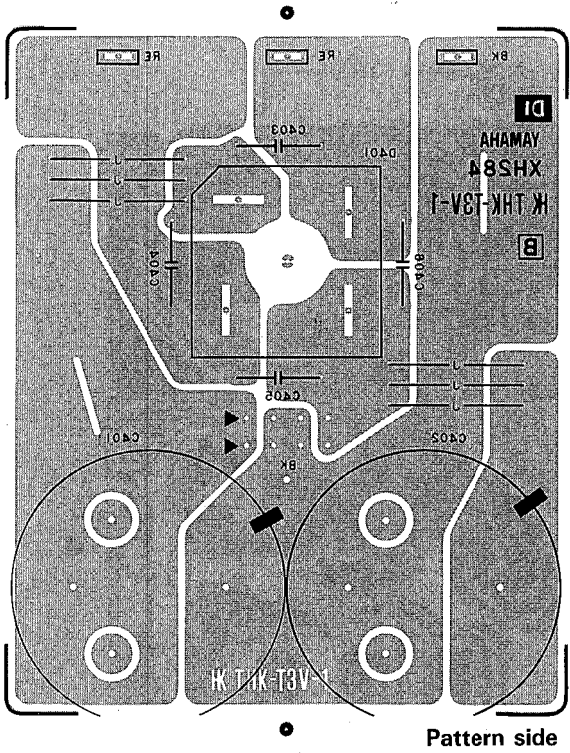

Notes)

- | | |
|------------------------------------|-------------------------------|
| Circuit Board: | DI (VI996700) XH284B0 (P2350) |
| 1. Diode Stack
D401: | KBPC25-04 (IH000390) 20A 40V |
| 2. Mylar Cap.
C403 ~ 406: | 0.01 μ 630V (FZ000650) |
| 3. Electrolytic Cap.
C401, 402: | 15000 μ 80V (FZ006780) |
| 4. Terminal: | (VA855400) 3 pcs |

● DI Circuit Board (P2700)

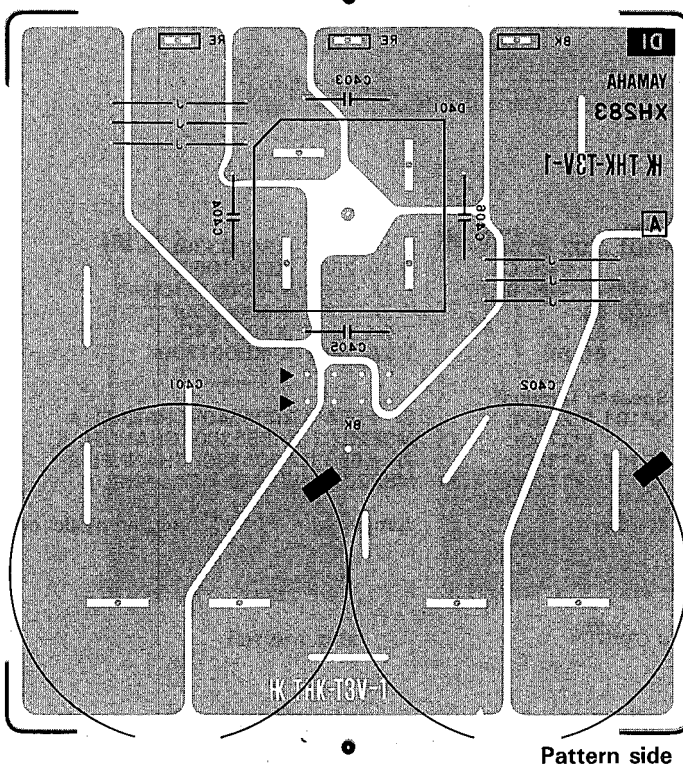

Notes)

- | | |
|------------------------------------|-------------------------------|
| Circuit Board: | DI (VI996600) XH283A0 (P2700) |
| 1. Diode Stack
D401: | KBPC25-04 (IH000390) 20A 40V |
| 2. Mylar Cap.
C403 ~ 406: | 0.01 μ 630V (FZ000650) |
| 3. Electrolytic Cap.
C401, 402: | 18000 μ 110V (VI575500) |
| 4. Terminal: | (VA855400) 3 pcs |

P2350/P2700

● FP Circuit Boards (P2350 Japanese, U.S. & Canadian models)

FP 1/3

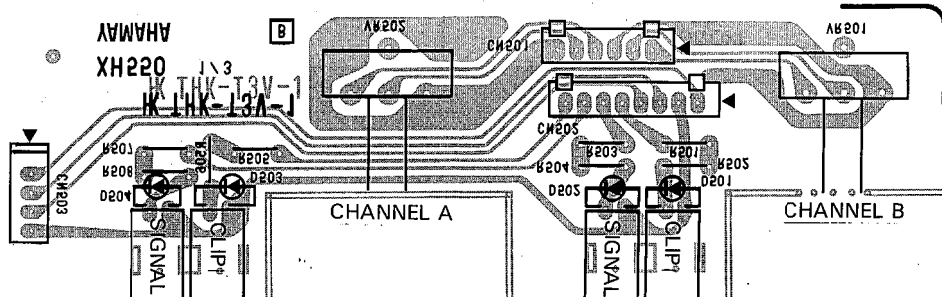

Pattern side

FP 2/3

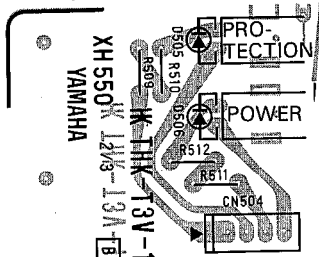

Components side

FP 3/3

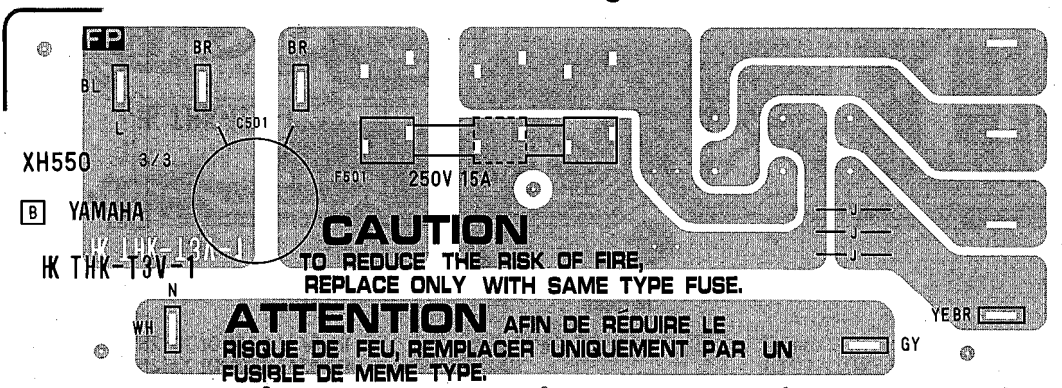

Components side

Notes)

- Circuit Board: FP (VJ051500) XH550B0 (P2350 J)
FP (VJ051600) XH550B0 (P2350 U, C)
- LED
D501, 503, 505, 506: TLR124 RE (IF001190) CLIP, PROTECT, POWER
D502, 504: TLG124 GR (VA767800) SIGNAL CHANNEL A, B
 - Variable Resistor
VR501, 502: 5K (VI575600) Input Att. A, B
 - Ceramic Cap.
C501: 0.01 μ 400V (FI384100)
 - Fuse
F501 (J): 15A 125V (KB001270)
(U, C): 15A 125V (KB001380)
 - Terminal: (VA855400) 6 pcs

DI (2350) : 3NA-VI99670 
DI (P2700) : 3NA-VI99660
FP (P2350 J.U.C) : 3NA-VI99630

● FP Circuit Boards (P2350 North European & British models)

FP 1/3

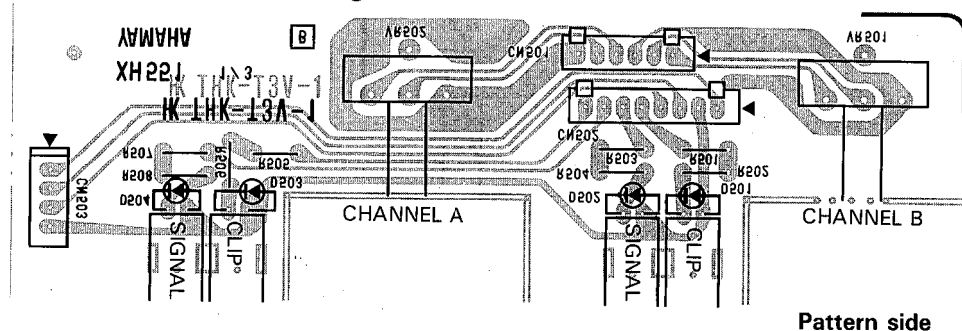

FP 2/3

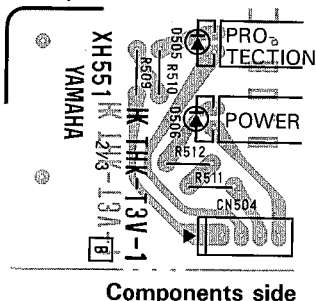

FP 3/3

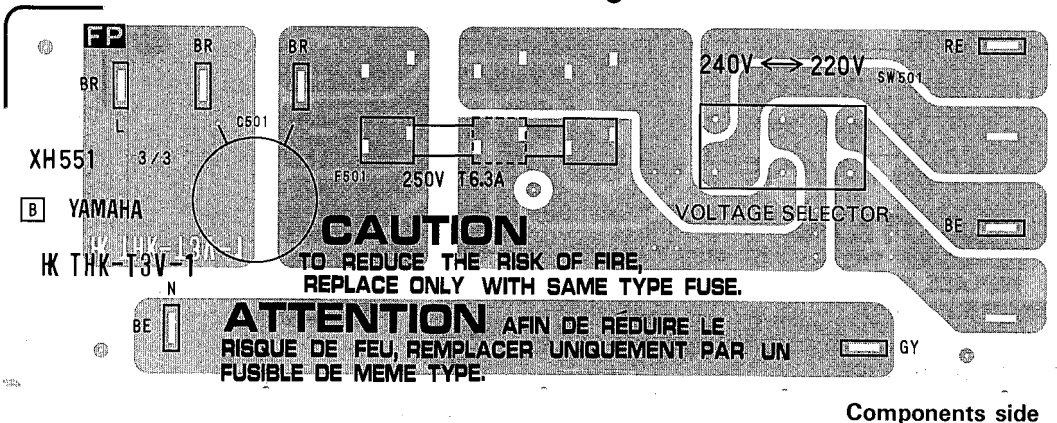

Notes)

- | | | | |
|----------------------|---|--------------|-------------------------------|
| Circuit Board: | FP (VJ051700) XH551B0 (P2350 H, B) | 5. Fuse | F501: T6.3A 250V S (KB000770) |
| 1. LED | D501, 503, 505, 506: TLR124 RE (IF001190) CLIP, PROTECT, POWER
D502, 504: TLG124 GR (VA767800) SIGNAL CHANNEL A, B | 6. Terminal: | (VA855400) 7 pcs |
| 2. Variable Resistor | VR501, 502: 5K (VI575600) Input Att. A, B | | |
| 3. Ceramic Cap. | C501: 0.01 μ 400V (FI384100) | | |
| 4. Slide Switch | SW501: VOLTAGE SELECT (VE206000) | | |

P2350/P2700

● FP Circuit Boards (P2700 Japanese & Canadian models)

FP 1/3

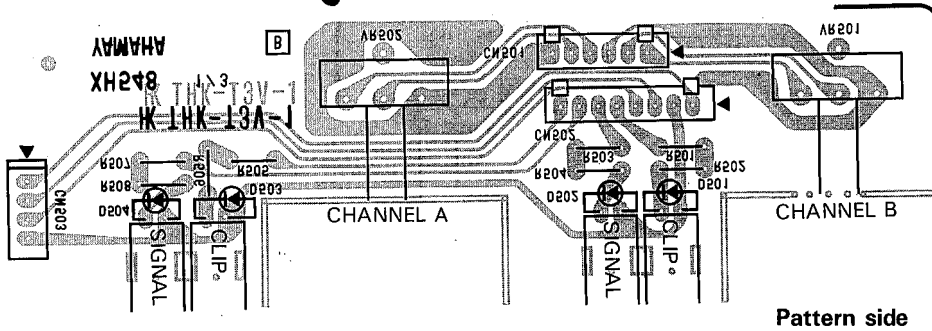

FP 2/3

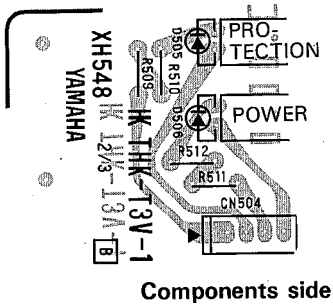

FP 3/3

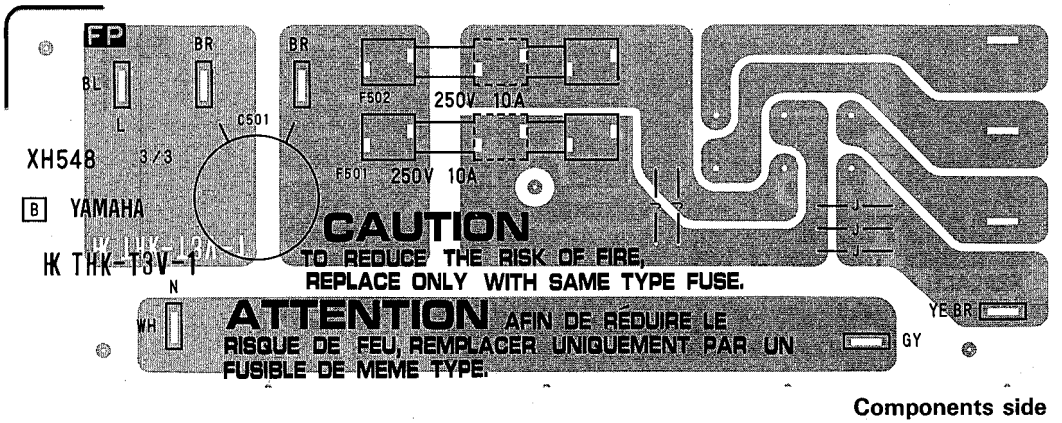

P2350/P2700

XH548 XH585 XH248 XH220 XH221

Notes)

- | | |
|----------------------|--|
| Circuit Board: | FP (VI996300) XH548B0 (P2700 J)
FP (VJ143600) XH548B0 (P2700 C) |
| 1. LED | |
| D501, 503, 505, 506: | TLR124 RE (IF001190) CLIP, PROTECT, POWER |
| D502, 504: | TLG124 GR (VA767800) SIGNAL CHANNEL A, B |
| 2. Variable Resistor | |
| VR501, 502: | 5K (VI575600) Input Att. A, B |
| 3. Ceramic Cap. | |
| C501: | 0.01 μ 400V (FI384100) |
| 4. Fuse | |
| F501, 502 (J): | 10A 250V (KB001490) |
| (C): | 10A 250V (KB001390) |
| 5. Terminal: | (VA855400) 6 pcs |

● FP Circuit Boards (P2700 U.S. model)

FP 1/3

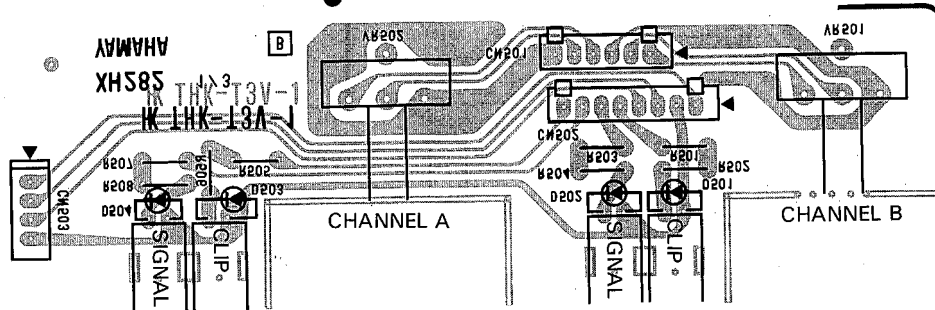

FP 2/3

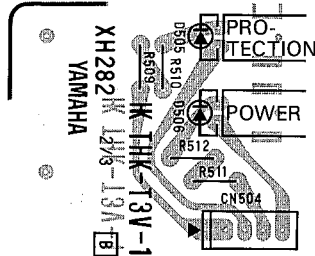

FP 3/3

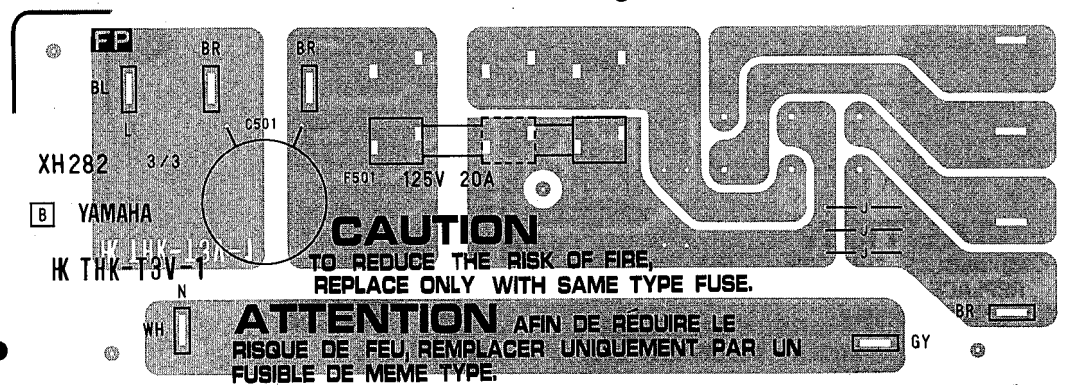

Notes)

- Circuit Board: FP (VI996400) XH282B0 (P2700 U)
- LED
D501, 503, 505, 506: TLR124 RE (IF001190) CLIP, PROTECT, POWER
D502, 504: TLG124 GR (VA767800) SIGNAL CHANNEL A, B
 - Variable Resistor
VR501, 502: 5K (VI575600) Input Att. A, B
 - Ceramic Cap.
C501: 0.01 μ 400V (FI384100)
 - Fuse
F501: 20A 125V (VJ087400)
 - Terminal: (VA855400) 6 pcs

● FP Circuit Boards (P2700 North European & British models)

FP 1/3

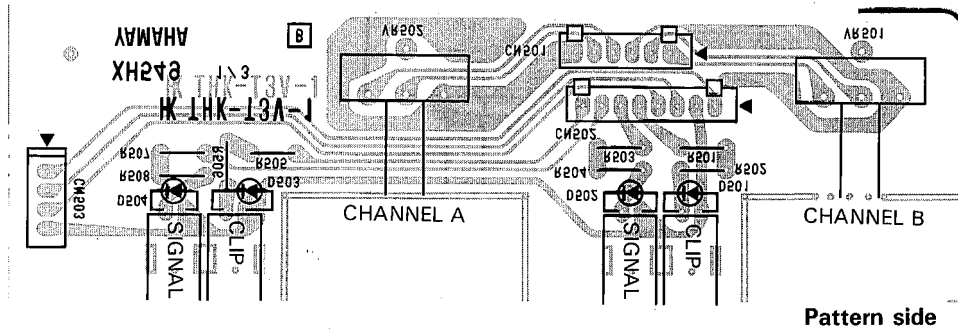

FP 2/3

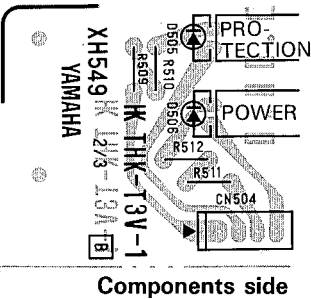

FP 3/3

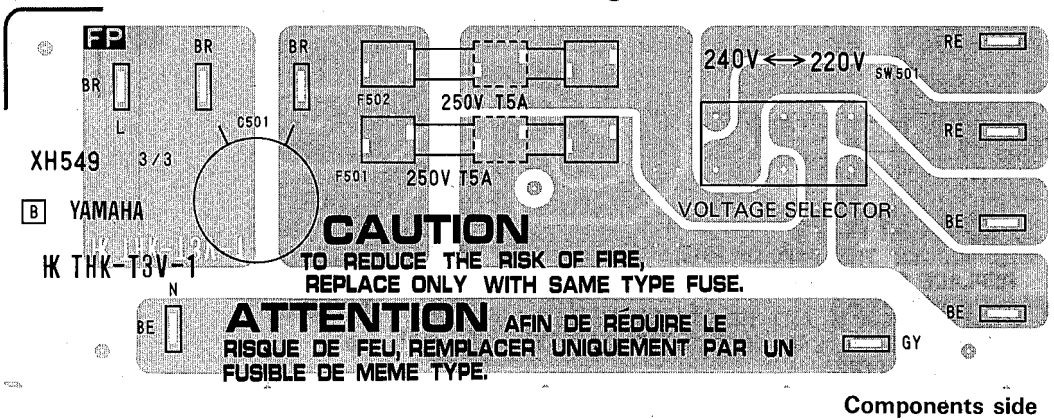

Notes)

- | | | | |
|----------------------|---|--------------|----------------------------------|
| Circuit Board: | FP (VI996500) XH549B0 (P2700 H, B) | 5. Fuse | F501, 502: T5A 250V S (KB000780) |
| 1. LED | D501, 503, 505, 506: TLR124 RE (IF001190) CLIP, PROTECT, POWER
D502, 504: TLG124 GR (VA767800) SIGNAL CHANNEL A, B | 6. Terminal: | (VA855400) 9 pcs |
| 2. Variable Resistor | VR501, 502: 5K (VI575600) Input Att. A, B | | |
| 3. Ceramic Cap. | C501: 0.01 μ 400V (FI384100) | | |
| 4. Slide Switch | SW501: VOLTAGE SELECT (VE206000) | | |

P2350/P2700

POWER AMPLIFIER

P2350

PARTS LIST

Notes DESTINATION ABBREVIATIONS

J : Japanese model	A : Australian model
U : U.S. model	E : European model
C : Canadian model	D : West German model
X : General model	B : British model
M : South African model	I : Indonesian model
H : North European model	

OVERALL ASSEMBLY

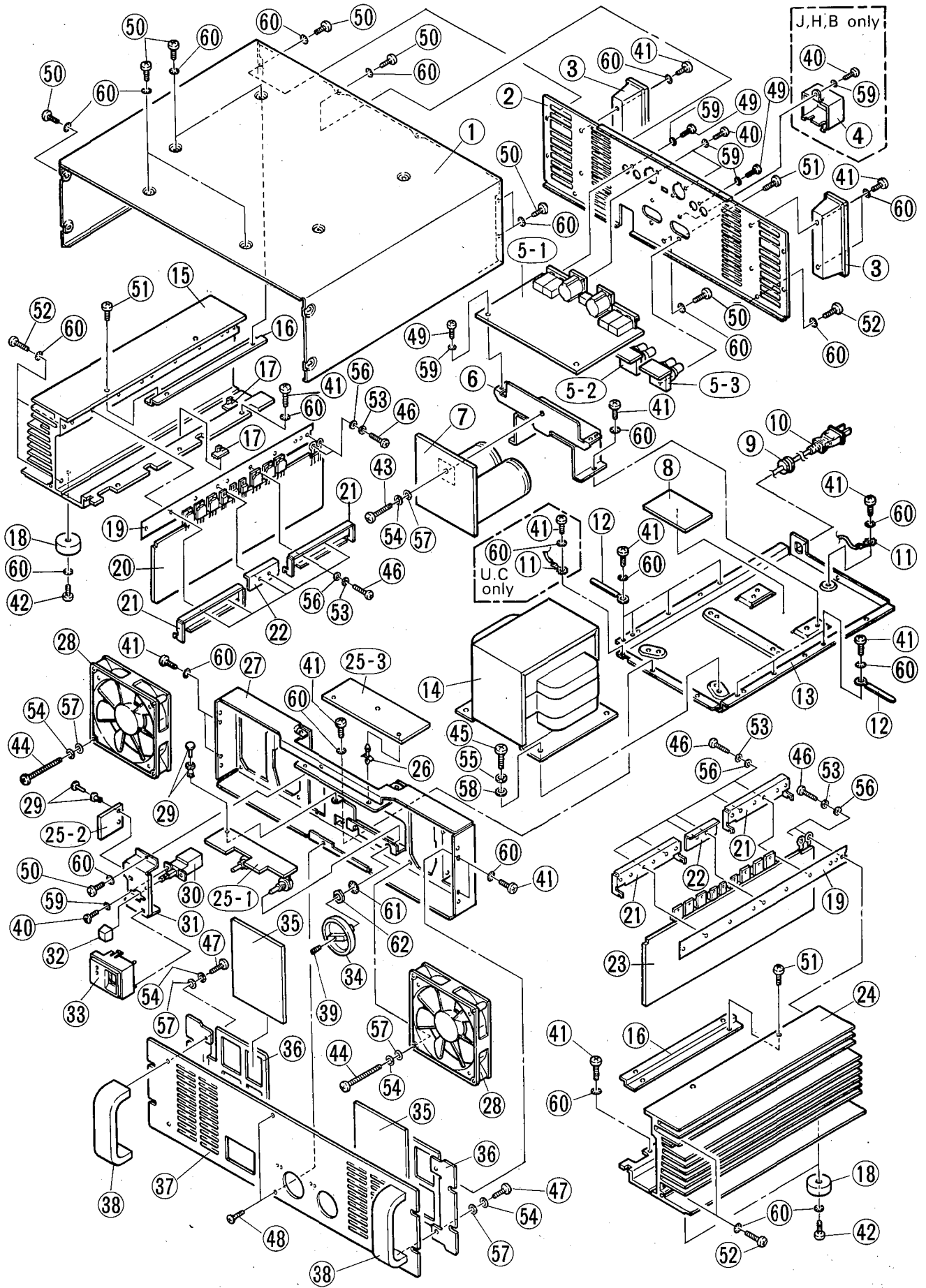

P2350/P2700

Ref. No.	Part No.	Description	部品名	Remarks	ランク
1	VJ054200	Top Cover	トップカバー	P2350	
2	VJ055300	Rear Panel	リアパネル	J	
2	VJ055400	Rear Panel	リアパネル	U	
2	VJ055500	Rear Panel	リアパネル	C	
2	VJ055600	Rear Panel	リアパネル	H	
2	VJ055700	Rear Panel	リアパネル	B	
3	CB808650	Cord Reel	コードリール		03
4	VE845600	Cover, SP Terminal	端子カバー	J, H, B	03
5	VJ143200	Circuit Board	IN シート	J	
5	VJ143300	Circuit Board	IN シート	U, C	
5	VJ143500	Circuit Board	IN シート	H, B	
5-1		Circuit Board	IN 1/3		
5-2		Circuit Board	IN 2/3		
5-3		Circuit Board	IN 3/3		
6	VJ054400	Holder, E.C.	ケミコンホルダー		
7	VI997600	Circuit Board	DI シート		
8	VJ057400	Spacer, E.C.	ケミコンスペーサー		
9	CB806850	Cord Strain Relief	SR-6N3-4	J	02
9	VB669000	Cord Strain Relief	SR-7P-2	U, C	02
9	CB032840	Cord Strain Relief	SR-5N-4	H, B	01
10	NG000610	AC Cord	15A 2.1m	電源コード	06
10	VD280500	AC Cord	15A 2.5m	電源コード	08
10	VD280100	AC Cord	6A 2.5m	電源コード	07
10	VH890300	AC Cord	6A 2.5m	電源コード	09
11	LA003690	Lug Terminal	ラグ端子	2pcs	01
12	CB817510	Cord Clamper	S-14B	束線止め	7pcs
13	VJ078400	Chassis, Transformer		J	
13	VJ078500	Chassis, Transformer		U, C	
13	VJ078600	Chassis, Transformer		H, B	
14	XH244A00	Power Transformer	電源トランス	J	
14	XH245A00	Power Transformer	電源トランス	U, C	
14	XH246A00	Power Transformer	電源トランス	H, B	
15	VJ054500	Heat Sink	Left	放熱板(左)	
16	VJ226000	Angle Bracket, Heat Sink		ヒートシンクアングル	
17	CB095100	Holder, Cord	ヒートシンクケーブル	4pcs	01
18	CB806590	Foot	ABS (BL)	アンブレグ	01
19	VJ098900	Insulation Sheet		放熱シート	
20	VI997600	Circuit Board	PAA	PAA シート	
21	VJ054600	Holder-L, Transistor		トランジスタ押え金具(大)	
22	VJ054700	Holder-S, Transistor		トランジスタ押え金具(小)	
23	VI997900	Circuit Board	PAB	PAB シート	
24	VJ225800	Heat Sink	Right	放熱板(右)	
25	VJ051500	Circuit Board	FP	FP シート	J
25	VJ051600	Circuit Board	FP	FP シート	U, C
25	VJ051700	Circuit Board	FP	FP シート	H, B
25-1		Circuit Board	FP 1/3	FP シート 1/3	
25-2		Circuit Board	FP 2/3	FP シート 2/3	
25-3		Circuit Board	FP 3/3	FP シート 3/3	
26	CB035390	Supporter	LCBS-6S	サポーター	3pcs
27	VJ055800	Sub Chassis		サブシャーシ	
28	VJ290100	Fan Assembly		ファン Ass'y	
29	CB602970	Plastic Rivet	NO. 920	プラスチックリベット	3pcs
30	KA804970	Push Switch	ESB-99119R-F	プッシュスイッチ	POWER (J)
30	VG023100	Push Switch	SDDZA1	プッシュスイッチ	POWER (U)
30	KA804980	Push Switch	ESB-9933T-F	プッシュスイッチ	POWER (C)
30	KA804990	Push Switch	ESB-9917S-F	プッシュスイッチ	POWER (H, B)
31	VJ056400	Angle Bracket, SW		スイッチアングル	
32	CB812380	Push Button		プッシュボタン	POWER
33	VJ056500	Escutcheon, SW		スイッチエスケッション	
34	VJ099000	Attenuator Knob		アッテネーターノブ	Input Att. A/B
35	VJ057300	Fan Filter		ファンフィルター	
36	VJ056300	Panel Angle		パネルアングル	
37	VJ056100	Front Panel		フロントパネル	
38	VJ056200	Handle		ハンドル	
39	VJ099100	Set Screw	4.0×8 FCM3BL	おすりわり付止めネジ	
40	ED330086	Bind Head Screw	3.0×8 FCM3BL	バインド小ネジ	01
41	ED340086	Bind Head Screw	4.0×8 FCM3BL	バインド小ネジ	01
42	ED340106	Bind Head Screw	4.0×10 FCM3BL	バインド小ネジ	01
43	ED340166	Bind Head Screw	4.0×16 FCM3BL	バインド小ネジ	01
44	VE702700	Bind Head Screw	4.0×35 FCM3BL	バインド小ネジ	
45	ED350106	Bind Head Screw	5.0×10 FCM3BL	バインド小ネジ	01
46	EA030126	Pan Head Screw	3.0×12 ZMC2Y	ナベ小ネジ	01
47	EA340106	Pan Head Screw	4.0×10 FCM3BL	ナベ小ネジ	01
48	EB330086	Flat Head Screw	3.0×8 FCM3BL	皿小ネジ	01
49	EI330086	Bind Head Tapping Screw	3.0×8 FCM3BL	ハントタッピングネジ	01
50	EI340086	Bind Head Tapping Screw	4.0×8 FCM3BL	ハントタッピングネジ	01
51	EI340106	Bind Head Tapping Screw	4.0×10 FCM3BL	ハントタッピングネジ	01
52	EI340126	Bind Head Tapping Screw	4.0×12 FCM3BL	ハントタッピングネジ	01
53	EV300036	Spring Washer	φ 3.0 ZMC2Y	バネ座金	01

* New Parts (新規部品)

ランク : Japan only

Ref. No.	Part No.	Description		部 品 名	Remarks	ランク
54	EV303406	Spring Washer	φ 4.0 FCM3BL	バネ座金		01
55	EV303056	Spring Washer	φ 5.0 FCM3BL	バネ座金		01
56	EV200036	Flat Washer	φ 3.0 ZMC2Y	平座金		01
57	EV203046	Flat Washer	φ 4.0 FCM3BL	平座金		01
58	EV203056	Flat Washer	φ 5.0 FCM3BL	平座金		01
59	EV413036	Toothed Lock Washer	A φ 3.0 FCM3BL	歯付座金内歯形		01
60	EV413046	Toothed Lock Washer	A φ 4.0 FCM3BL	歯付座金内歯形		01
61	ET800120	Toothed Lock Washer	A φ 8.0 FCM3BL	歯付座金内歯形		01
62	EX800136	Hexagonal Nut	φ 8.0 FCM3BL	特殊六角ナット		01

* New Parts (新規部品)

ランク: Japan only

P2350/P2700

ELECTRICAL PARTS

Ref. No.	Part No.	Description	部品名	Remarks	ランク
	VI997600	Circuit Board	PAA	PAAシート	P2350
	VI997900	Circuit Board	PAB	PABシート	
	VI996700	Circuit Board	DI	DIシート	
	VJ143200	Circuit Board	IN	INシート	
	VJ143300	Circuit Board	IN	INシート	J U,C
	VJ143500	Circuit Board	IN	INシート	H,B
	VJ051500	Circuit Board	FP	FPシート	J
	VJ051600	Circuit Board	FP	FPシート	J U,C
	VJ051700	Circuit Board	FP	FPシート	H,B
	VI997600	Circuit Board	PAA	PAAシート	
	IA097000	Transistor	2SA970 GR,BL	トランジスタ	
	IC224000	Transistor	2SC2240 GR,BL	トランジスタ	
	IC329810	Transistor	2SC3298	トランジスタ	
	IX805240	Transistor	2SA1546	トランジスタ	03
	IX805250	Transistor	2SC4001	トランジスタ	03
	IA130610	Transistor	2SA1306	トランジスタ	03
	IX609750	Transistor	2SA1492	トランジスタ	05
	IX609760	Transistor	2SC3856	トランジスタ	05
	IH000320	Diode	1S1888	ダイオード	01
	IF003450	Diode	1SS133	ダイオード	01
	VI783000	Diode	1SS146	ダイオード	
	HV353470	Flame Proof C. Resistor	4.7Ω 1/4W J	不燃酸化カーボン抵抗	01
	HV354100	Flame Proof C. Resistor	10Ω 1/4W J	不燃酸化カーボン抵抗	01
	HV354820	Flame Proof C. Resistor	82Ω 1/4W J	不燃酸化カーボン抵抗	01
	HV355100	Flame Proof C. Resistor	100Ω 1/4W J	不燃酸化カーボン抵抗	01
	HV355220	Flame Proof C. Resistor	220Ω 1/4W J	不燃酸化カーボン抵抗	
	HV356330	Flame Proof C. Resistor	3.3KΩ 1/4W J	不燃酸化カーボン抵抗	01
	HZ003600	Wire Wound Resistor	0.47Ω 5W K	セメント抵抗	02
	HM654100	Wire Wound Resistor	10Ω 5W	セメント抵抗	
	VC769900	Metal Oxide Film Resistor	4.7Ω 2W J	酸化金属被膜抵抗	04
	VE404900	Positive Thermistor	PTH59F04BE471TS	温度検知用ポジスタ	
	VI518000	Positive Thermistor	PTH487A01BG471	温度補償用ポジスタ	04
	VJ087200	Positive Thermistor	PTH487A01BH471	温度補償用ポジスタ	02
	HT410370	Trimmer Potentiometer	B470 3P H1052A	半固定抵抗	
	FU350500	Maica Cap.	5P 500V J	マイカコン	01
	FU351150	Maica Cap.	15P 500V J	マイカコン	01
	FZ005200	Mylar Cap.	0.1μ 100V K	マイラコン	01
	UH296470	Electrolytic Cap.	4.7μ 100V	ケミコン	01
	GD900580	Coil	2mH GD90058 GY	空芯コイル	
	KC001410	Relay	DC24V JC2AD	リレー	07
	VG864300	Heat Sink	DPS(15)-30	ヒートシンク	02
	LA004870	Terminal Pin	1.0mm 14L	ストッパ付カクビン	01
	ED330086	Bind Head Screw	3.0×8 FCM3BL	スクリュー小ネジ	01
	EV303306	Spring Washer	φ3.0 ZMC2BL	バネ座金	01 for TR (2pcs) for TR (2pcs)
	VI997900	Circuit Board	PAB	PABシート	
	IA097000	Transistor	2SA970 GR,BL	トランジスタ	
	IC224000	Transistor	2SC2240 GR,BL	トランジスタ	
	IC329810	Transistor	2SC3298	トランジスタ	
	IX805240	Transistor	2SA1546	トランジスタ	03
	IX805250	Transistor	2SC4001	トランジスタ	03
	IA130610	Transistor	2SA1306	トランジスタ	03
	IX609750	Transistor	2SA1492	トランジスタ	05
	IX609760	Transistor	2SC3856	トランジスタ	05
	IH000320	Diode	1S1888	ダイオード	01
	IF003450	Diode	1SS133	ダイオード	01
	VI783000	Diode	1SS146	ダイオード	
	HV353470	Flame Proof C. Resistor	4.7Ω 1/4W J	不燃酸化カーボン抵抗	01
	HV354100	Flame Proof C. Resistor	10Ω 1/4W J	不燃酸化カーボン抵抗	01
	HV354820	Flame Proof C. Resistor	82Ω 1/4W J	不燃酸化カーボン抵抗	01
	HV355100	Flame Proof C. Resistor	100Ω 1/4W J	不燃酸化カーボン抵抗	01
	HV355220	Flame Proof C. Resistor	220Ω 1/4W J	不燃酸化カーボン抵抗	
	HV356330	Flame Proof C. Resistor	3.3KΩ 1/4W J	不燃酸化カーボン抵抗	01
	HZ003600	Wire Wound Resistor	0.47Ω 5W K	セメント抵抗	02
	HM654100	Wire Wound Resistor	10Ω 5W	セメント抵抗	
	VC769900	Metal Oxide Film Resistor	4.7Ω 2W J	酸化金属被膜抵抗	04
	VE404900	Positive Thermistor	PTH59F04BE471TS	温度検知用ポジスタ	
	VI518000	Positive Thermistor	PTH487A01BG471	温度補償用ポジスタ	04
	VJ087200	Positive Thermistor	PTH487A01BH471	温度補償用ポジスタ	02
	HT410370	Trimmer Potentiometer	B470 3P H1052A	半固定抵抗	
	FU350500	Maica Cap.	5P 500V J	マイカコン	01
	FU351150	Maica Cap.	15P 500V J	マイカコン	01
	FZ005200	Mylar Cap.	0.1μ 100V K	マイラコン	01
	UH296470	Electrolytic Cap.	4.7μ 100V	ケミコン	01
	GD900580	Coil	2mH GD90058 GY	空芯コイル	
	KC001410	Relay	DC24V JC2AD	リレー	07
	VG864300	Heat Sink	DSP(15)-30	ヒートシンク	02
	LA004870	Terminal Pin	1.0mm 14L	ストッパ付カクビン	01

* New Parts (新規部品)

ランク : Japan only

P2350/P2700

Ref. No.	Part No.	Description	部品名	Remarks	ランク	
	ED330086 EV303306	Bind Head Screw Spring Washer	3.0×8 FCM3BL φ 3.0 ZNC2BL	バインド小ネジ バネ座金	for TR (2pcs) for TR (2pcs)	01 01
	VI996700 IH000390	Circuit Board. Diode Stack	DI KBPC25-04	D I シート ダイオードスタック	20A 40V	09
	FZ000650 FZ006780 VA855400 LA003690	Mylar Cap. Electrolytic Cap. Terminal Lug Terminal	0.01μ 630V 15000μ 80V	マイラーコン ケミコンラゲ端子 ラゲ端子	3pcs 1pc.	02 10 01 01
	VJ143200 VJ143300 VJ143500 XA013001 XD853A00	Circuit Board Circuit Board Circuit Board IC IC	IN IN IN M5238P NJM7815FA	I N シート I N シート I N シート I C I C	J U,C H,B OP AMP. REGULATOR	04 03
	XD854A00 IG034800 IA097000 IC224000 IC329840	IC IC Transistor Transistor Transistor	NJM7915FA TA7317P 2SA970 GR,BL 2SC2240 GR,BL 2SC3298	I C I C トランジスタ トランジスタ トランジスタ	REGULATOR SP PROTECTION	03 04 03 03 03
	IF003450 IH001540 IH001120 IH001400 VB067600	Diode Diode Diode Stack Diode Stack Metal Film Resistor	ISS133 10E-1 S2VB20 2A 200V 1G4B1 1.5A 400V 12KΩ 1/5W F	ダイオード ダイオード ダイオードスタック ダイオードスタック 金属皮膜抵抗		01 01 03 03
	VA074600 VB068900 FH223470 UJ658470 UJ849100	Metal Film Resistor Metal Film Resistor Ceramic Cap. Electrolytic Cap. Electrolytic Cap.	15KΩ 1/5W F 51KΩ 1/5W F 0.0047μ 500V M 470μ 35V 1000μ 25V	金属皮膜抵抗 金属皮膜抵抗 セラミックコン ケミコン		01 02
	KA401280 LB202300 LB302320 KB000330 KB000350	Slide Switch Phone Jack XLB Connector Fuse Fuse	SSP32204 HLJ1520 XLB-3-31PCV T 1A 250V T 2A 250V	スライドスイッチ ホンジャック キヤノンジャック ヒューズ ヒューズ	MODE (J,U,H,B) INPUT CH.A/B INPUT CH.A/B	03 02 07 01 01
	KB001060 KB001240 KB001330 KB001770 LB201530	Fuse Fuse Fuse Fuse Fuse Holder	T 1A 250V T 2A 250V T2A 250V S T1A 250V S PC-FH1	ヒューズ ヒューズ ヒューズ ヒューズ ヒューズホルダー	J U,C H,B H,B	02 03 02 02 01
	LA005530 LA005540 BA808520 VG223500 ED330086	Speaker Terminal Speaker Terminal Heat Sink Angle Bracket, Jack Bind Head Screw	2P #553 2P #554 T220M 25L 3.0×8 FCM3BL	スピーカ端子 スピーカ端子 放熱板 J A C K アングル バインド小ネジ	SPEAKER CH.B SPEAKER CH.A	06 06 03 02 01
	EV303306 VJ051500 VJ051600 VJ051700	Spring Washer Circuit Board Circuit Board Circuit Board	φ 3.0 ZNC2BL	バネ座金 F P シート F P シート F P シート	for TR (1pc.) for TR (1pc.)	01 01 01
	IF001190 VA767800 VI575600 FI384100 VE206000	LED LED Variable Resistor Ceramic Cap. Slide Switch	TLR124 RE TLG124 GR 5K 0.01μ 400V VOLTAGE SELECT	L E D L E D ロータリーボリューム 規格認定コン スライドスイッチ	CLIP, PROTECT, PW SIGNAL CH.A/B Input Att. A/B	02 01 01 03
	VH870600 KB001270 KB001380 KB000770 LB201530	LED Socket Fuse Fuse Fuse Fuse Holder	15A 125V 15A 250V T6.3A 250V S PC-FH1	L E D ソケット ヒューズ ヒューズ ヒューズ ヒューズホルダー	6pcs J U,C H,B	01 01 04 03 01
	VA855400 KA804970 VG023100 KA804980 KA804990	Terminal Push Switch Push Switch Push Switch Push Switch		P C 用カラゲ端子 プッシュスイッチ プッシュスイッチ プッシュスイッチ プッシュスイッチ	6pcs (H:7pcs) POWER (J) POWER (U) POWER (C) POWER (H,B)	01 06 06 06 06
	VJ290100 XH244A00 XH245A00 XH246A00	Fan Assembly Power Transformer Power Transformer Power Transformer		ファン Ass'y 電源トランス 電源トランス 電源トランス		06 08 07 09
	MG000610 VD280500 VD280100 VH890300	AC Cord AC Cord AC Cord AC Cord	15A 2.1m 15A 2.5m 6A 2.5m 6A 2.5m	電源コード 電源コード 電源コード 電源コード	J U,C H B	06 08 07 09

* New Parts (新規部品)

ランク : Japan only

POWER AMPLIFIER

P2700

PARTS LIST

Notes DESTINATION ABBREVIATIONS

J : Japanese model	A : Australian model
U : U.S. model	E : European model
C : Canadian model	D : West German model
X : General model	B : British model
M : South African model	I : Indonesian model
H : North European model	

OVERALL ASSEMBLY

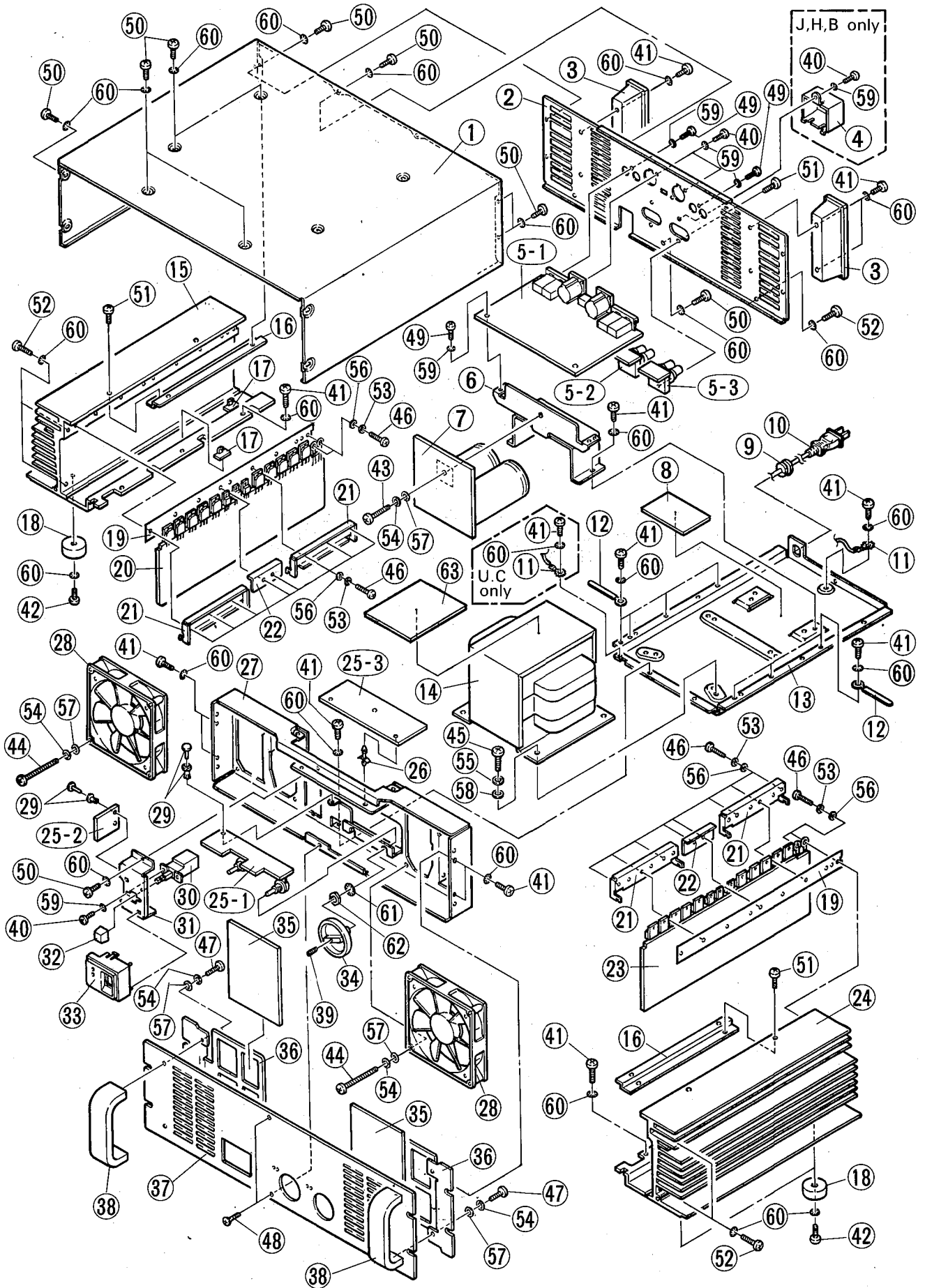

P2350/P2700

Ref. No.	Part No.	Description	部品名	Remarks	ランク
1	VJ054200	Top Cover	トップカバー	P2700	
2	VJ054800	Rear Panel	リアパネル	J	
2	VJ054900	Rear Panel	リアパネル	U	
2	VJ055000	Rear Panel	リアパネル	C	
2	VJ055100	Rear Panel	リアパネル	H	
2	VJ055200	Rear Panel	リアパネル	B	
3	CB808650	Cord Reel	コードリール		03
4	VE845600	Cover, SP Terminal	端子カバー	J, H, B	03
5	VI996000	Circuit Board	IN シート	J	
5	VI996100	Circuit Board	IN シート	U	
5	VI997000	Circuit Board	IN シート	C	
5	VI996200	Circuit Board	IN シート	H, B	
5-1		Circuit Board	IN 1/3		
5-2		Circuit Board	IN 2/3		
5-3		Circuit Board	IN 3/3		
6	VJ054300	Holder E.C.	ホルダー		
7	VI996600	Circuit Board	DI シート		
8	VJ057400	Spacer, E.C.	スペーサー		
9	CB806850	Cord Strain Relief	コードストッパー	J	02
9	VB669000	Cord Strain Relief	コードストッパー	U, C	02
9	CB032840	Cord Strain Relief	コードストッパー	H, B	01
10	MG000610	AC Cord	電源コード	J	06
10	VD280500	AC Cord	電源コード	U, C	08
10	VD280100	AC Cord	電源コード	H	07
10	VH890300	AC Cord	電源コード	B	09
11	LA003690	Lug Terminal	端子	2pcs	01
12	CB817510	Cord Clamper	束線止め	7pcs	01
13	VJ078400	Chassis, Transformer	S-14B	J	
13	VJ078500	Chassis, Transformer	トランス	U, C	
13	VJ078600	Chassis, Transformer	トランス	H, B	
14	XH059A00	Power Transformer	電源トランス	J	
14	XH060A00	Power Transformer	電源トランス	U, C	
14	XH061A00	Power Transformer	電源トランス	H, B	
15	VJ054500	Heat Sink	放熱板(左)		
16	VJ226000	Angle Bracket, Heat Sink	ヒートシンクアングル		
17	CB095100	Holder, Cord	コードホルダー	4pcs	01
18	CB806590	Foot	アンブレグ		01
19	VJ098900	Insulation Sheet	放熱シート		
20	VI997500	Circuit Board	PAA シート		
21	VJ054600	Holder-L, Transistor	トランジスタ押え金具(大)		
22	VJ054700	Holder-S, Transistor	トランジスタ押え金具(小)		
23	VI997800	Circuit Board	PAB シート		
24	VJ225800	Heat Sink	放熱板(右)		
25	VI996300	Circuit Board	FP シート	J	
25	VI996400	Circuit Board	FP シート	U	
25	VJ143600	Circuit Board	FP シート	C	
25	VI996500	Circuit Board	FP シート	H, B	
25-1		Circuit Board	FP 1/3		
25-2		Circuit Board	FP 2/3		
25-3		Circuit Board	FP 3/3		
26	CB035390	Supporter	サポート	3pcs	01
27	VJ055800	Sub Chassis	サブシャーシ		
28	VJ290100	Fan Assembly	ファンアッセンブリ		
29	CB602970	Plastic Rivet	プラスチックリベット	3pcs	01
30	KA804970	Push Switch	ブッシュスイッチ	POWER (I)	06
30	VG023100	Push Switch	SDDZA1	POWER (U)	
30	KA804980	Push Switch	ESB-9933T-F	POWER (C)	06
30	KA804990	Push Switch	ESB-9917S-F	POWER (H, B)	06
31	VJ056400	Angle Bracket, SW	スイッチアングル		
32	CB812380	Push Button	ブッシュボタン	POWER	01
33	VJ056500	Escutcheon, SW	スイッチエスケッション		
34	VJ099000	Attenuator Knob	アッテネーターノブ	Input Att. A/B	
35	VJ057300	Fan Filter	ファンフィルター		
36	VJ056300	Panel Angle	パネルアングル		
37	VJ056000	Front Panel	フロントパネル		
38	VJ056200	Handle	ハンドル		
39	VJ099100	Set Screw	4.0×8 FCM3BL		
40	ED330056	Bind Head Screw	3.0×8 FCM3BL	すりわり付止めネジ	01
41	ED340086	Bind Head Screw	4.0×8 FCM3BL	バインド小ネジ	01
42	ED340106	Bind Head Screw	4.0×10 FCM3BL	バインド小ネジ	01
43	ED340166	Bind Head Screw	4.0×16 FCM3BL	バインド小ネジ	01
44	VE702700	Bind Head Screw	4.0×35 FCM3BL	バインド小ネジ	
45	ED350106	Bind Head Screw	5.0×10 FCM3BL	バインド小ネジ	01
46	EA030126	Pan Head Screw	3.0×12 ZMC2Y	ナベ小ネジ	01
47	EA340106	Pan Head Screw	4.0×10 FCM3BL	ナベ小ネジ	01
48	EB330086	Flat Head Screw	3.0×8 FCM3BL	皿小ネジ	01
49	EI330086	Bind Head Tapping Screw	3.0×8 FCM3BL	ハインドタッピングネジ	01
50	EI340086	Bind Head Tapping Screw	4.0×8 FCM3BL	ハインドタッピングネジ	01
51	EI340106	Bind Head Tapping Screw	4.0×10 FCM3BL	ハインドタッピングネジ	01

* New Parts (新規部品)

ランク : Japan only

Ref. No.	Part No.	Description		部品名	Remarks	ランク
52	EI340126	Bind Head Tapping Screw	4.0×12 FCM3BL	ハ ^ク イント ^ト タッピ ^ン クネジ ^ク		01
53	EV300036	Spring Washer	φ3.0 ZMC2Y	パ ^ナ ネ ^座 金		01
54	EV303406	Spring Washer	φ4.0 FCM3BL	パ ^ナ ネ ^座 金		01
55	EV303056	Spring Washer	φ5.0 FCM3BL	パ ^ナ ネ ^座 金		01
56	EV200036	Flat Washer	φ3.0 ZMC2Y	平 ^座 金		01
57	EV203046	Flat Washer	φ4.0 FCM3BL	平 ^座 金		01
58	EV203056	Flat Washer	φ5.0 FCM3BL	平 ^座 金		01
59	EV413036	Toothed Lock Washer	A φ3.0 FCM3BL	歯 ^付 座 ^金 内 ^歯 形		01
60	EV413046	Toothed Lock Washer	A φ4.0 FCM3BL	歯 ^付 座 ^金 内 ^歯 形		01
* 61	ET800120	Toothed Lock Washer	A φ8.0 FCM3BL	歯 ^付 座 ^金 内 ^歯 形		01
62	EX800136	Hexagonal Nut	φ8.0 FCM3BL	特 ^殊 六 ^角 ナ ^ツ ト		01
* 63	VJ566100	Stopper Rubber		防 ^振 ゴ ^ム		

P2350/P2700

* New Parts (新規部品)

ELECTRICAL PARTS

Ref. No.	Part No.	Description	部品名	Remarks	ランク	
	VI997500	Circuit Board	PAA	P A A シート	P2700	
	VI997800	Circuit Board	PAB	P A B シート		
	VI996600	Circuit Board	DI	D I シート		
	VI996000	Circuit Board	IN	I N シート		J
	VI996100	Circuit Board	IN	I N シート		U
	VI997000	Circuit Board	IN	I N シート	C H,B	
	VI996200	Circuit Board	IN	I N シート		
	VI996300	Circuit Board	FP	F P シート		
	VI996400	Circuit Board	FP	F P シート		J
	VJ143600	Circuit Board	FP	F P シート		U C
	VI996500	Circuit Board	FP	F P シート	H,B	
	VI997500	Circuit Board	PAA	P A A シート		
	IA097000	Transistor	2SA970 GR,BL	トランジスタ		03
	IC224000	Transistor	2SC2240 GR,BL	トランジスタ		03
	IC329810	Transistor	2SC3298	トランジスタ		03
	IX805240	Transistor	2SA1546	トランジスタ		03
	IX805250	Transistor	2SC4001	トランジスタ		03
	IA130650	Transistor	2SA1306B	トランジスタ		03
	IC329850	Transistor	2SC3298B	トランジスタ		03
	IX609750	Transistor	2SA1492	トランジスタ		05
	IX609760	Transistor	2SC3856	トランジスタ		05
	IHO00320	Diode	1S1888	ダイオード	01	
	IF003450	Diode	1SS133	ダイオード	01	
	VI783000	Diode	1SS146	ダイオード	01	
	HV353470	Flame Proof C. Resistor	4.7Ω 1/4W J	不燃化カーボン抵抗	01	
	HV354100	Flame Proof C. Resistor	10Ω 1/4W J	不燃化カーボン抵抗	01	
	HV354820	Flame Proof C. Resistor	82Ω 1/4W J	不燃化カーボン抵抗	01	
	HV355100	Flame Proof C. Resistor	100Ω 1/4W J	不燃化カーボン抵抗	01	
	HV355220	Flame Proof C. Resistor	220Ω 1/4W J	不燃化カーボン抵抗	01	
	HV356330	Flame Proof C. Resistor	3.3KΩ 1/4W J	不燃化カーボン抵抗	01	
	HZ003600	Wire Wound Resistor	0.47Ω 5W K	セメント抵抗	02	
	HM654100	Wire Wound Resistor	10Ω 5W	セメント抵抗	02	
	VC769900	Metal Oxide Film Resistor	4.7Ω 2W J	酸化金属被膜抵抗	04	
	VE404900	Positive Thermistor	PTH59F04BE471TS	温度検知用ポジスタ	04	
	VI518000	Positive Thermistor	PTH487A01BG471	温度補償用ポジスタ	BIAS ADJ.	04
	VJ087200	Positive Thermistor	PTH487A01BH471	温度補償用ポジスタ		
	HT410370	Trimmer Potentiometer	B470 3P H1052A	温度固定抵抗		02
	FU350500	Maica Cap.	5P 500V J	マイカコン		01
	FU351150	Maica Cap.	15P 500V J	マイカコン		01
	FZ005200	Mylar Cap.	0.1μ 100V K	マイラーコン	01	
	UJ706470	Electrolytic Cap.	4.7μ 160V	ケミコン		
	GD900580	Coil	2mH GD90058 GY	空芯コイル	01	
	KC001410	Relay	DC24V JC2AD	リレー	07	
	VG864300	Heat Sink	DPS(15)-30	ヒートシンク	02	
	LA004870	Terminal Pin	1.0mm 14L	ストッパ	01	
	ED330086	Bind Head Screw	3.0×8 FCM3BL	バンド小ネジ	01	
	EV303306	Spring Washer	φ3.0 ZMC2BL	バネ座金	01	
	VI997800	Circuit Board	PAB	P A B シート		
	IA097000	Transistor	2SA970 GR,BL	トランジスタ		03
	IC224000	Transistor	2SC2240 GR,BL	トランジスタ		03
	IC329810	Transistor	2SC3298	トランジスタ		03
	IX805240	Transistor	2AA1546	トランジスタ		03
	IX805250	Transistor	2SC4001	トランジスタ		03
	IA130650	Transistor	2SA1306B	トランジスタ		03
	IC329850	Transistor	2SC3298B	トランジスタ		03
	IX609750	Transistor	2SA1492	トランジスタ		05
	IX609760	Transistor	2SC3856	トランジスタ		05
	IHO00320	Diode	1S1888	ダイオード	01	
	IF003450	Diode	1SS133	ダイオード	01	
	VI783000	Diode	1SS146	ダイオード	01	
	HV353470	Flame Proof C. Resistor	4.7Ω 1/4W J	不燃化カーボン抵抗	01	
	HV354100	Flame Proof C. Resistor	10Ω 1/4W J	不燃化カーボン抵抗	01	
	HV354820	Flame Proof C. Resistor	82Ω 1/4W J	不燃化カーボン抵抗	01	
	HV355100	Flame Proof C. Resistor	100Ω 1/4W J	不燃化カーボン抵抗	01	
	HV355220	Flame Proof C. Resistor	220Ω 1/4W J	不燃化カーボン抵抗	01	
	HV356330	Flame Proof C. Resistor	3.3KΩ 1/4W J	不燃化カーボン抵抗	01	
	HZ003600	Wire Wound Resistor	0.47Ω 5W K	セメント抵抗	02	
	HM654100	Wire Wound Resistor	10Ω 5W	セメント抵抗	02	
	VC769900	Metal Oxide Film Resistor	4.7Ω 2W J	酸化金属被膜抵抗	04	
	VE404900	Positive Thermistor	PTH59F04BE471TS	温度検知用ポジスタ	04	
	VI518000	Positive Thermistor	PTH487A01BG471	温度補償用ポジスタ	04	
	VJ087200	Positive Thermistor	PTH487A01BH471	温度補償用ポジスタ	BIAS ADJ.	
	HT410370	Trimmer Potentiometer	B470 3P H1052A	温度固定抵抗		02
	FU350500	Maica Cap.	5P 500V J	マイカコン		01
	FU351150	Maica Cap.	15P 500V J	マイカコン	01	
	FZ005200	Mylar Cap.	0.1μ 100V K	マイラーコン	01	
	UJ706470	Electrolytic Cap.	4.7μ 160V	ケミコン	01	

P2350/P2700

4 * New Parts (新規部品)

ランク : Japan only

Ref. No.	Part No.	Description	部品名	Remarks	ランク	
	GD900580	Coil	2mH GD90058 GY	空芯コイル	01	
	KC001410	Relay	DC24V JC2AD	リレー	07	
	VG864300	Heat Sink	DPS(15)-30	ヒートシンク	02	
	LA004870	Terminal Pin	1.0mm 14L	ストッパ付カクピン	01	
	ED330086	Bind Head Screw	3.0×8 FCM3BL	バインド小ネジ	01	
	EV303306	Spring Washer	φ 3.0 ZMC2BL	バネ座金	for TR (2pcs) for TR (2pcs)	01
	VI996600	Circuit Board	DI	D I シート		
	IH000390	Diode Stack	KBPC25-04	ダイオードスタック	20A 40V	09
	FZ000650	Mylar Cap.	0.01μ 630V	マイラーコン		02
	VI575500	Electrolytic Cap.	18000μ 110V	ケミコン		
	VA855400	Terminal		P C 用カラゲ端子	3pcs	01
	LA003690	Lug Terminal		ラグ端子	1pc.	01
	VI996000	Circuit Board	IN	I N シート	J	
	VI996100	Circuit Board	IN	I N シート	U	
	VI997000	Circuit Board	IN	I N シート	C	
	VI996200	Circuit Board	IN	I N シート	H, B	
	XA013001	IC	M5238P	I C	OP AMP.	04
	XD853A00	IC	NJM7815FA	I C	REGULATOR	03
	XD854A00	IC	NJM7915FA	I C	REGULATOR	03
	IG034800	IC	TA7317P	I C	SP PROTECTION	04
	IA097000	Transistor	2SA970 GR, BL	トランジスタ		03
	IC224000	Transistor	2SC2240 GR, BL	トランジスタ		03
	IC329840	Transistor	2SC3298	トランジスタ		03
	IF003450	Diode	1SS133	ダイオード		01
	IH001540	Diode	10E-1	ダイオード		01
	IH001120	Diode Stack	S2VB20 2A 200V	ダイオードスタック		03
	IH001400	Diode Stack	1G4B1 1.5A 400V	ダイオードスタック		03
	VB067600	Metal Film Resistor	12KΩ 1/5W F	金属皮膜抵抗		
	VA074600	Metal Film Resistor	15KΩ 1/5W F	金属皮膜抵抗		01
	VB068900	Metal Film Resistor	51KΩ 1/5W F	金属皮膜抵抗		
	FH223470	Ceramic Cap.	0.0047μ 500V M	セラコン (E)		01
	UJ658470	Electrolytic Cap.	470μ 35V	ケミコン		02
	UJ849100	Electrolytic Cap.	1000μ 25V	ケミコン		
	KA401280	Slide Switch	SSP32204	スライドスイッチ	MODE (J, U, H, B)	03
	LB202300	Phone Jack	HLJ1520	ホーンジャック	INPUT CH. A/B	02
	LB302320	XLB Connector	XLB-3-31PCV	キョノンジャック	INPUT CH. A/B	07
	KB000330	Fuse	T 1A 250V	ヒューズ	J	01
	KB000350	Fuse	T 2A 250V	ヒューズ	J	01
	KB001060	Fuse	T 1A 250V	ヒューズ	U, C	02
	KB001240	Fuse	T 2A 250V	ヒューズ	U, C	03
	KB001330	Fuse	T2A 250V S	ヒューズ	H, B	02
	KB001770	Fuse	T1A 250V S	ヒューズ	H, B	02
	LB201530	Fuse Holder	PC-FH1	ヒューズホルダー		01
	VI1314700	Speaker Terminal	MSP202	スピーカ端子	SPEAKER CH. B	07
	VI1356300	Speaker Terminal	MSP202-1	スピーカ端子	SPEAKER CH. A	07
	BA808520	Heat Sink	T220M 25L	放熱板		03
	VG223500	Angle Bracket, Jack	EMX	J A C K アングル		02
	ED330086	Bind Head Screw	3.0×8 FCM3BL	バインド小ネジ	for TR (1pc.)	01
	EV303306	Spring Washer	φ 3.0 ZMC2BL	バネ座金	for TR (1pc.)	01
	VI996300	Circuit Board	FP	F P シート	J	
	VI996400	Circuit Board	FP	F P シート	U	
	VJ143600	Circuit Board	FP	F P シート	C	
	VI996500	Circuit Board	FP	F P シート	H, B	
	IF001190	LED	TLR124 RE	L E D	CLIP, PROTECT, PW	02
	VA767800	LED	TLG124 GR	L E D	SIGNAL CH. A/B	01
	VI575600	Variable Resistor	5K	ロータリーボリューム	Input Att. A/B	
	FI384100	Ceramic Cap.	0.01μ 400V	規格認定コン		01
	VE206000	Slide Switch	VOLTAGE SELECT	スライドスイッチ	H, B	03
	VH870600	LED Socket		LEDソケット	6pcs	01
	KB001490	Fuse	10A 250V	ヒューズ	J	01
	VJ087400	Fuse	20A 125V	ヒューズ	U	
	KB001390	Fuse	10A 250V	ヒューズ	C	03
	KB000780	Fuse	T5A 250V S	ヒューズ	H, B	02
	LB201530	Fuse Holder	PC-FH1	ヒューズホルダー		01
	VA855400	Terminal		P C 用カラゲ端子	6pcs (H:9pcs)	01
	KA804970	Push Switch	ESB-99119R-F	プッシュスイッチ	POWER (J)	06
	VG023100	Push Switch	SDDZA1	プッシュスイッチ	POWER (U)	
	KA804980	Push Switch	ESB-9933T-F	プッシュスイッチ	POWER (C)	06
	KA804990	Push Switch	ESB-9917S-F	プッシュスイッチ	POWER (H, B)	06
	VJ290100	Fan Assembly		ファン Ass'y		
	XH059A00	Power Transformer		電源トランス	J	
	XH060A00	Power Transformer		電源トランス	U, C	
	XH061A00	Power Transformer		電源トランス	H, B	

Ref. No.	Part No.	Description		部品名	Remarks	ランク
	MG000610	AC Cord	15A 2.1m	電源コード	J	06
	VD280500	AC Cord	15A 2.5m	電源コード	U, C	08
	VD280100	AC Cord	6A 2.5m	電源コード	H	07
	VII890300	AC Cord	6A 2.5m	電源コード	B	09

* New Parts (新規部品)

ランク : Japan only

P2350/P2700

P2350/P2700 OVERALL CIRCUIT DIAGRAM

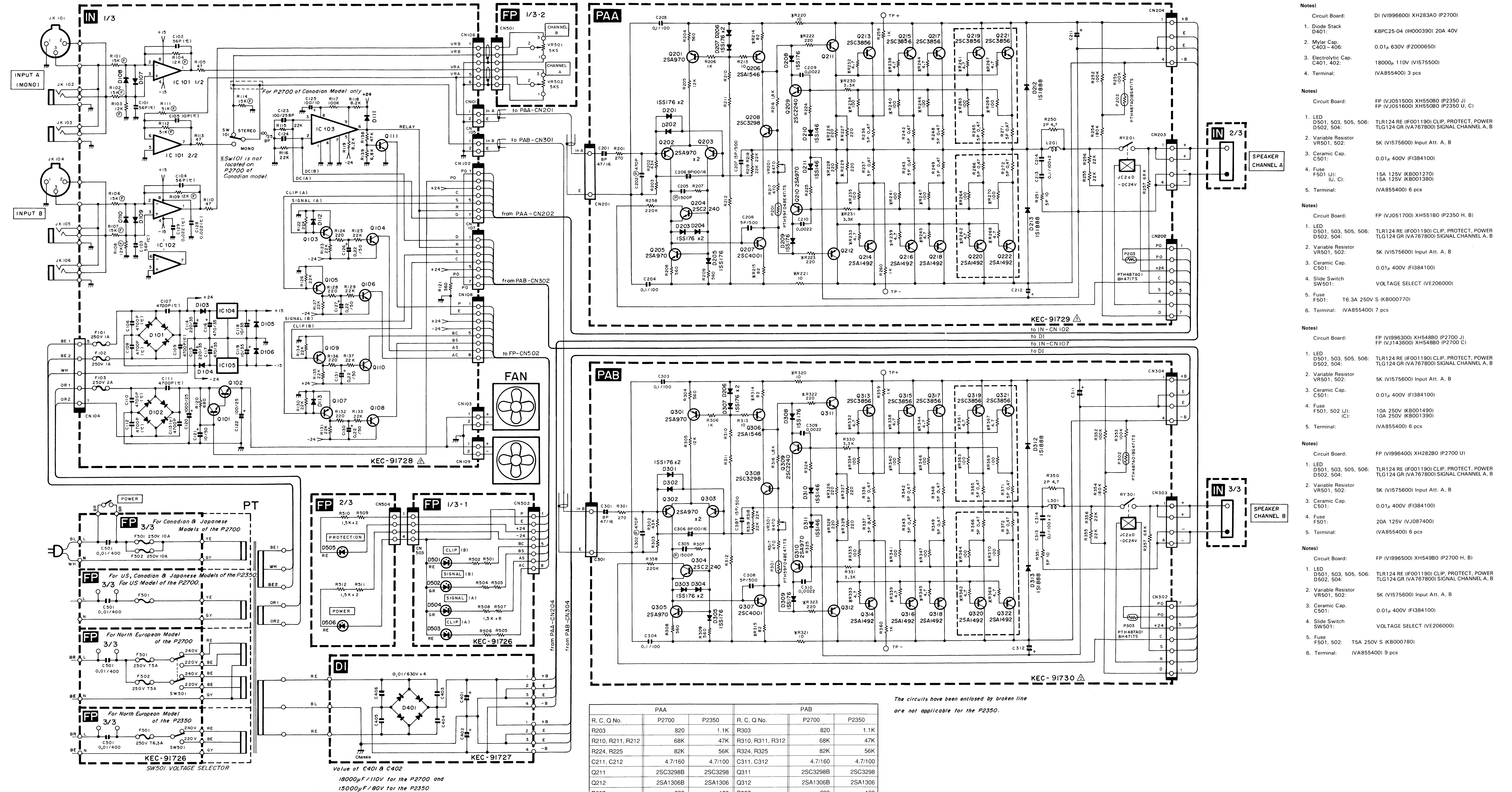

- Notes)
- Circuit Board: DI (V1996600) XH283A0 (P2700)
- Diode Stack D401: K8PC25-04 (IH000390) 20A 40V
 - Mylar Cap. C403-406: 0.01µ 630V (FZ000650)
 - Electrolytic Cap. C401, 402: 1800µ, 110V (V1575500)
 - Terminal: (VA855400) 3 pcs
- Notes)
- Circuit Board: FP (VJ051500) XH55080 (P2350 U, C) FP (VJ051600) XH55080 (P2350 U, C)
- LED D501, 503, 505, 506: TLR124 RE (IF001190) CLIP, PROTECT, POWER TLG124 GR (VA767800) SIGNAL CHANNEL A, B
 - Variable Resistor VR501, 502: 5K (V1575600) Input Att. A, B
 - Ceramic Cap. C501: 0.01µ 400V (F1384100)
 - Fuse F501 (J): 15A 125V (KB001270) (U, C); 15A 125V (KB001380) (I, C)
 - Terminal: (VA855400) 6 pcs
- Notes)
- Circuit Board: FP (VJ051700) XH55180 (P2350 H, B)
- LED D501, 503, 505, 506: TLR124 RE (IF001190) CLIP, PROTECT, POWER TLG124 GR (VA767800) SIGNAL CHANNEL A, B
 - Variable Resistor VR501, 502: 5K (V1575600) Input Att. A, B
 - Ceramic Cap. C501: 0.01µ 400V (F1384100)
 - Slide Switch SW501: VOLTAGE SELECT (VE206000)
 - Fuse F501: T6.3A 250V S (KB000770) (I, C)
 - Terminal: (VA855400) 7 pcs
- Notes)
- Circuit Board: FP (V1996300) XH54880 (P2700 J) FP (VJ143600) XH54880 (P2700 C)
- LED D501, 503, 505, 506: TLR124 RE (IF001190) CLIP, PROTECT, POWER TLG124 GR (VA767800) SIGNAL CHANNEL A, B
 - Variable Resistor VR501, 502: 5K (V1575600) Input Att. A, B
 - Ceramic Cap. C501: 0.01µ 400V (F1384100)
 - Fuse F501, 502 (J): 10A 250V (KB001490) (I, C); 10A 250V (KB001390) (I, C)
 - Terminal: (VA855400) 6 pcs
- Notes)
- Circuit Board: FP (V1996400) XH28280 (P2700 U)
- LED D501, 503, 505, 506: TLR124 RE (IF001190) CLIP, PROTECT, POWER TLG124 GR (VA767800) SIGNAL CHANNEL A, B
 - Variable Resistor VR501, 502: 5K (V1575600) Input Att. A, B
 - Ceramic Cap. C501: 0.01µ 400V (F1384100)
 - Fuse F501: 20A 125V (VJ087400) (I, C)
 - Terminal: (VA855400) 6 pcs
- Notes)
- Circuit Board: FP (V1996500) XH54980 (P2700 H, B)
- LED D501, 503, 505, 506: TLR124 RE (IF001190) CLIP, PROTECT, POWER TLG124 GR (VA767800) SIGNAL CHANNEL A, B
 - Variable Resistor VR501, 502: 5K (V1575600) Input Att. A, B
 - Ceramic Cap. C501: 0.01µ 400V (F1384100)
 - Slide Switch SW501: VOLTAGE SELECT (VE206000)
 - Fuse F501, 502: T5A 250V S (KB000780) (I, C)
 - Terminal: (VA855400) 9 pcs

The circuits have been enclosed by broken line are not applicable for the P2350.

R, C, Q No.	P2700	P2350	R, C, Q No.	P2700	P2350
R203	820	1.1K	R303	820	1.1K
R210, R211, R212	68K	47K	R310, R311, R312	68K	47K
R224, R225	82K	56K	R324, R325	82K	56K
C211, C212	4.7/160	4.7/100	C311, C312	4.7/160	4.7/100
Q211	2SC3298B	2SC3298	Q311	2SC3298B	2SC3298
Q212	2SA1306B	2SA1306	Q312	2SA1306B	2SA1306
R207	220	120	R307	220	120

- Notes)
- Circuit Board: PAA (V1997600) XG961B0 (P2350) PAA (V1997500) XG961B0 (P2700)
- Transistor Q201-203, 210: 2SA970 GR, BL (IA097000) 2SC2240 GR, BL (IC224000) Q204, 205, 209: 2SA1546 (IX805240) 2SC4001 (IX805250) Q207: 2SC3298 (IC329810) Q208: 2SC3298 (IC329810) Q211 (P2350): 2SC3298 (IC329810) 2SC3298B (IC329850) Q212 (P2350): 2SA1306 (IA130610) 2SA1306B (IA130650) (P2700): 2SC3856 (IX609760) 2SA1492 (IX609750) Q219, 221: 2SC3856 (IX609760) Q220, 222: 2SA1492 (IX609750)
 - Diode D201-209: 1SS133 (IF003450) D210, 211: 1SS146 (V1783000) D212, 213: 1S1888 (IH000320)
 - Flame Proof Carbon Resistor R214, 215: 100 1/4W J (HV354820) R220, 221: 100 1/4W J (HV354100) R222, 223: 220 1/4W J (HV355220) 226-229: 3.3K 1/4W J (HV356330) R230, 231: 220 1/4W J (HV353470) R232, 233, 238: 239, 244, 245: 4.7 1/4W J (HV353470) R234, 235, 240: 241, 246, 247: 1000 1/4W J (HV355100) R261, 262, 267, 268: 4.7 1/4W J (HV354700) (P2700 only) R263, 264, 269, 270: 1000 1/4W J (HV355100) (P2700 only)
 - Wire Wound Resistor R236, 237, 243: 243, 248, 249: 0.47Ω 5W K (HZ003600) R251: 100 5W (HM854100) R265, 266, 271, 272: 0.47Ω 5W K (HZ003600) (P2700 only)
 - Metal Oxide Film Resistor R250: 4.7Ω 2W J (VC769900)
 - Positive Thermistor P201: PTH59F048E471TS (VE404900) P202: PTH487A01B4711 (V1518000) P203: PTH487A01B4711 (VJ087200)
 - Trimmer Potentiometer VR201: B470 3P H1052A (HT410370) BIAS ADJ.
 - Maica Cap. C207: 15P 500V J (FU351150) C208: 5P 500V J (FU350500)
 - Mylar Cap. C203, 204, 213, 214: 0.1µ 100V K (FZ005200)
 - Electrolytic Cap. C211, 212 (P2350): 4.7µ 100V (UH296470) (P2700): 4.7µ 160V (UJ706470)
 - Coil L201: 2mH GD90058 GY (GD900580)
 - Relay RY201: DC24V JC2AD (KC001410)

- Notes)
- Circuit Board: PAB (V1997900) XH28080 (P2350) PAB (V1997800) XH28080 (P2700)
- Transistor Q301-303, 310: 2SA970 GR, BL (IA097000) Q304, 305, 309: 2SC2240 GR, BL (IC224000) Q306: 2SA1546 (IX805240) Q307: 2SC4001 (IX805250) Q308: 2SC3298 (IC329810) Q311 (P2350): 2SC3298 (IC329810) 2SC3298B (IC329850) Q312 (P2350): 2SA1306 (IA130610) 2SA1306B (IA130650) (P2700): 2SC3856 (IX609760) 2SA1492 (IX609750) Q319, 321: 2SC3856 (IX609760) (P2700 only) Q320, 322: 2SA1492 (IX609750) (P2700 only)
 - Diode D301-309: 1SS133 (IF003450) D310, 311: 1SS146 (V1783000) D312, 313: 1S1888 (IH000320)
 - Flame Proof Carbon Resistor R314, 315: 820 1/4W J (HV354820) R320, 321: 100 1/4W J (HV354100) R322, 323: 220 1/4W J (HV355220) 326-329: 3.3K 1/4W J (HV356330) R330, 331: 220 1/4W J (HV353470) R332, 333, 338: 239, 244, 245: 4.7 1/4W J (HV353470) R334, 335, 340: 241, 246, 247: 1000 1/4W J (HV355100) R361, 362, 367, 368: 4.7 1/4W J (HV354700) (P2700 only) R363, 364, 369, 370: 1000 1/4W J (HV355100) (P2700 only)
 - Wire Wound Resistor R336, 337, 342: 343, 348, 349: 0.47Ω 5W K (HZ003600) R351: 100 5W (HM854100) R365, 366, 371, 372: 0.47Ω 5W K (HZ003600) (P2700 only)
 - Metal Oxide Film Resistor R350: 4.7Ω 2W J (VC769900)
 - Positive Thermistor P301: PTH59F048E471TS (VE404900) P302: PTH487A01B4711 (V1518000) P303: PTH487A01B4711 (VJ087200)
 - Trimmer Potentiometer VR301: B470 3P H1052A (HT410370) BIAS ADJ.
 - Maica Cap. C307: 15P 500V J (FU351150) C308: 5P 500V J (FU350500)
 - Mylar Cap. C303, 304, 313, 314: 0.1µ 100V K (FZ005200)
 - Electrolytic Cap. C311, 312 (P2350): 4.7µ 100V (UH296470) (P2700): 4.7µ 160V (UJ706470)
 - Coil L301: 2mH GD90058 GY (GD900580)
 - Relay RY301: DC24V JC2AD (KC001410)

- Notes)
- Circuit Board: IN (VJ143200) XH28180 (P2350 J) IN (VJ143300) XH28180 (P2350 U, C) IN (VJ143500) XH28180 (P2350 H, B) IN (V1996000) XH28180 (P2700 U, C) IN (V1996100) XH28180 (P2700 U, C) IN (V1997000) XH28180 (P2700 J) IN (V1998200) XH28180 (P2700 H, B)
- IC I101, 102: M528P (XA013001) OP AMP I103: T7371P (IK034800) SP PROTECTION I104: NJM7815FA (XK85A00) REGULATOR I105: NJM7915FA (XK85A00) REGULATOR
 - Transistor Q101, 104, 106, 111: 2SC2240 GR, BL (IC224000) Q102: 2SC3298 (IC329840) Q103, 105, 107, 109: 2SA970 GR, BL (IA097000)
 - Diode D101-106, 111: 10E1 (IH001540) D107-110, 112, 113: 1SS133 (IF003450)
 - Diode Stack D101: 1G481 1.5A 400V (IH001400) D102: S2VB20 2A 200V (IH001120)
 - Metal Film Resistor R101, 102, 106, 107: 15K 1/5W F (VA074600) R103, 104, 108, 109: 12K 1/5W F (VB067800) R111, 112, 114: 51K 1/5W F (VB068900)
 - Ceramic Cap. C106-113: 0.0047µ 500V M (FH223470)
 - Electrolytic Cap. C116, 117, C120: 470µ 35V (IJ658470) 1000µ 25V (IJ849100)
 - Slide Switch SW101: SSP32204 (KA401280) MODE (J, U, H, B)
 - Phone Jack JK102, 103, 105, 106: HLJ1520 (LB202300) INPUT CH.A,B
 - XLB Connector JK101, 104: XLB-3-31PC (LB302320) INPUT CHANNEL A, B
 - Fuse F101, 102 (J): T 1A 250V (KB000330) (U, C); T 1A 250V (KB001060) (I, B); T 2A 250V (KB000350) (U, C); T 2A 250V (KB001240) (I, B); T 2A 250V S (KB001330)
 - Speaker Terminal SP101 (P2350): 2P #554 (LA005540) CHANNEL A SP102 (P2350): 2P #553 (LA005530) CHANNEL B SP202 (V1314700) CHANNEL B (P2700): Jumper wire: P2700 Canadian model only